



READ THESE INSTRUCTIONS AND
AND SAVE THEM FOR FUTURE USE

Model # UT56TBC3M



Model # UT56WW3M



Installation Guide

For Models:

UT56TBC3M

UT56WW3M

Table of Contents:

Safety Tips. pg. 1

Unpacking Your Fan. pg. 2

Parts Inventory. pg. 2

Installation Preparation. pg. 3

Hanging Bracket Installation. pg. 3

Fan Assembly. pg. 4

Wiring. pg. 5

Canopy Assembly. pg. 6

Blade Assembly. pg. 6

Wall Control Operation. pg. 6

Testing Your Fan. pg. 7

Troubleshooting. pg. 7

Parts Replacement. pg. 7

Warranty. pg. 7



net weight of fan: 13.01 lb. (5.9 kg)

PRINTED IN CHINA

SAFETY TIPS.

WARNING: To reduce the risk of electrical shock, turn off the electricity to the fan at the main fuse box or circuit panel before you begin the fan installation or before servicing the fan or installing accessories.

1. **READ ALL INSTRUCTIONS AND SAFETY INFORMATION CAREFULLY BEFORE INSTALLING YOUR FAN AND SAVE THESE INSTRUCTIONS.**

CAUTION: To avoid personal injury, the use of gloves may be necessary while handling fan parts with sharp edges.

2. Make sure all electrical connections comply with Local Codes or Ordinances, the National Electrical Code, and ANSI/NFPA 70-1999. If you are unfamiliar with electrical wiring or if the house/building wires are different colors than those referred to in the instructions, please use a qualified electrician.
3. Make sure you have a location selected for your fan that allows clear space for the blades to rotate, and at least ten (10) feet (3.05 meters) of clearance between the floor and the fan blade tips. The fan should be mounted so that the tips of the blades are at least thirty (30) inches (76 centimeters) from walls or other upright structures.
4. The outlet box and ceiling support joist used must be securely mounted, and capable of supporting at least 35 pounds (16 kilograms). The outlet box must be supported directly by the building structure. Use only UL listed outlet boxes marked "FOR FAN SUPPORT."

WARNING: To reduce the risk of fire, electrical shock, or personal injury, mount to the outlet box marked "Acceptable for Fan Support," and use the mounting screws provided with the outlet box. Most outlet boxes commonly used for the support of lighting fixtures are not acceptable for fan support and may need to be replaced. Consult a qualified electrician if in doubt.

WARNING: To reduce the risk of fire, electrical shock, or personal injury, wire connectors provided with this fan are designed to accept only one 12 gauge house wire and two lead wires from the fan. If your house wire is larger than 12 gauge or there is more than one house wire to connect to the two fan lead wires, consult an electrician for the proper size wire connectors to use.

5. Electrical diagrams are for reference only. Light kits that are not packed with the fan must be UL listed and marked suitable for use with the model fan you are installing. Switches must be UL general use switches. Refer to the instructions packaged with the light kits and switches for proper assembly.
6. After installation is complete, check that all connections are absolutely secure.
7. After making electrical connections, spliced conductors should be turned upward and pushed carefully up into the outlet box. The wires should be spread apart with the grounded conductor and the equipment-grounding conductor on opposite sides of the outlet box.

WARNING: To reduce the risk of electrical shock, fire and to prevent humming noise do not use this fan with any solid state speed control device or control fan speed with a full range dimmer switch. [Using a full range dimmer switch to control fan speed will cause a loud humming noise from fan.]

8. Do not insert anything between the fan blades while they are rotating.

WARNING: To reduce the risk of personal injury, do not bend the blade arms during assembly or after installation. Do not insert objects into the path of the blades.

WARNING: To avoid personal injury or damage to the fan and other items, be cautious when working around or cleaning the fan.

9. Do not use water or detergents when cleaning the fan or fan blades. A dry dust cloth or lightly dampened cloth will be suitable for most cleaning.

WARNING: To reduce the risk of personal injury, use **only** parts provided with this fan. **The use of parts OTHER than those provided with this fan will void the warranty.**

NOTE: The important safety precautions and instructions appearing in the manual are not meant to cover all possible conditions and situations that may occur. It must be understood that common sense and caution are necessary factors in the installation and operation of this fan.

1. Unpacking Your Fan.

Carefully open the packaging. Remove items from Styrofoam inserts. Remove motor housing and place on carpet or Styrofoam to avoid damage to finish. Do not discard fan carton or Styrofoam inserts should this fan need to be returned for repairs.

Check against parts inventory that all parts have been included.

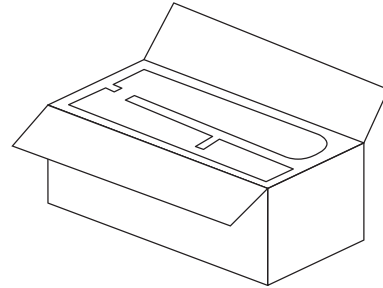

2. Parts Inventory.

- a. j-hook hanging bracket. 1 piece
- b. blade. 3 pieces
- c. motor housing, downrod and canopy (pre-assembled). 1 piece
- d. wall control. 1 piece
- e. hardware pack

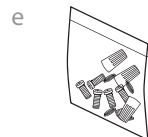
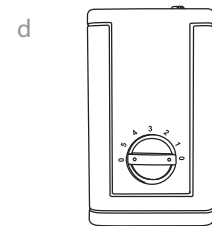
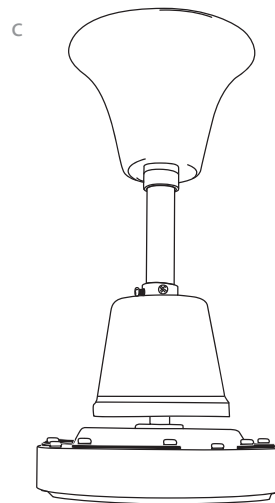
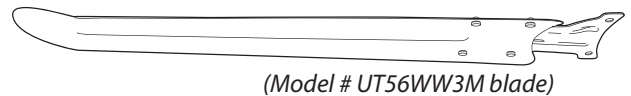
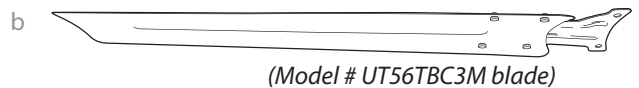
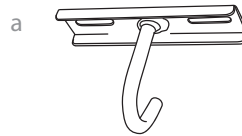

! IMPORTANT REMINDER: You must use the parts provided with this fan for proper installation and safety. **!**

3. Installation Preparation.

To prevent personal injury and damage, ensure that the hanging location allows the blades a clearance of 10ft. (3.05m) from the floor and 30in. (76cm) from any wall or obstruction.

This fan is suitable for room sizes up to 400 square feet (37.2 square meters).

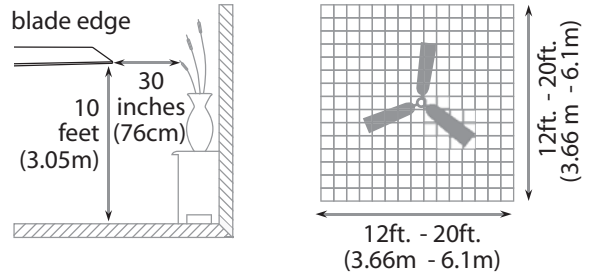

This fan can be mounted with a **downrod** on a normal ceiling **only**. Fan *cannot* mount as a flushmount installation *nor* on a vaulted ceiling.

Installation requires these tools:

Phillips screwdriver, flat-head screwdriver, adjustable pliers or wrench, stepladder, wire cutters, and rated electrical tape.

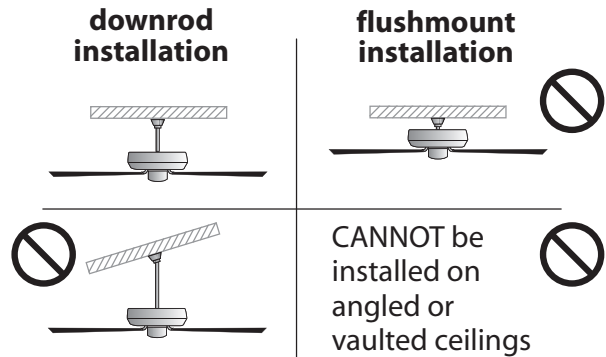

4. Hanging Bracket Installation.

Turn off circuit breakers to current fixture from breaker panel and be sure operating light switch is turned to the OFF position.

WARNING: Failure to disconnect power supply prior to installation may result in serious injury.

Remove existing fixture.

WARNING: When using an existing outlet box, be sure the outlet box is securely attached to the building structure and can support the full weight of the fan. Ensure outlet box is clearly marked "Suitable for Fan Support." If not, it must be replaced with an approved outlet box. Failure to do so can result in serious injury.

CAUTION: Be sure outlet box is properly grounded and that a ground (green or bare) wire is present.

Install hanging bracket to outlet box using original screws, spring washers and flat washers provided with new or original outlet box.* Arrange electrical wiring to the front or back side of the hanging bracket.

***Note:** It is very important that you use the proper hardware when installing the hanging bracket as this will support the fan.

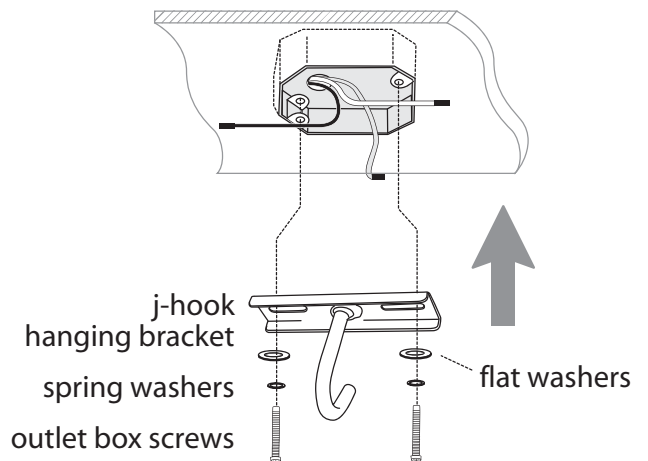
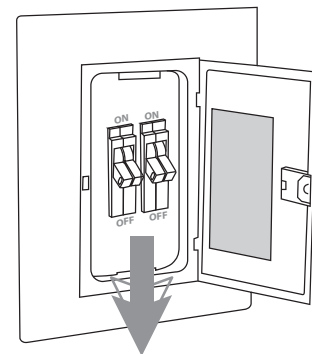

5. Fan Assembly.

Loosen canopy set screw and lower canopy to expose hanging bar. Separate electrical wiring and safety cable from rubber band. Lift fan onto j-hook hanging bracket and slide rubber bushing over hook. **Make the wiring connections as shown in Section 6 on the following page.**

Important: Find a secure attachment point (wood ceiling joist highly recommended) and secure safety cable--refer to diagram on the following page as well. Use a heavy duty wood screw, washer and lock washer (not supplied) over safety cable loop.

Adjust safety cable length by loosening screw and nut on safety cable vice. Adjust slack to a hand's length and tighten nut on vice securely. The loop at the end should just fit over the threads on the wood screw. Test cable by pulling on loose end with pliers. If cable slips, then vice and nut must be set tighter.

Extra cable slack can be left in ceiling area.

NOTE: The important safety precautions and instructions appearing in the manual are not meant to cover all possible conditions and situations that may occur. It must be understood that common sense and caution are necessary factors in the installation and operation of this fan.

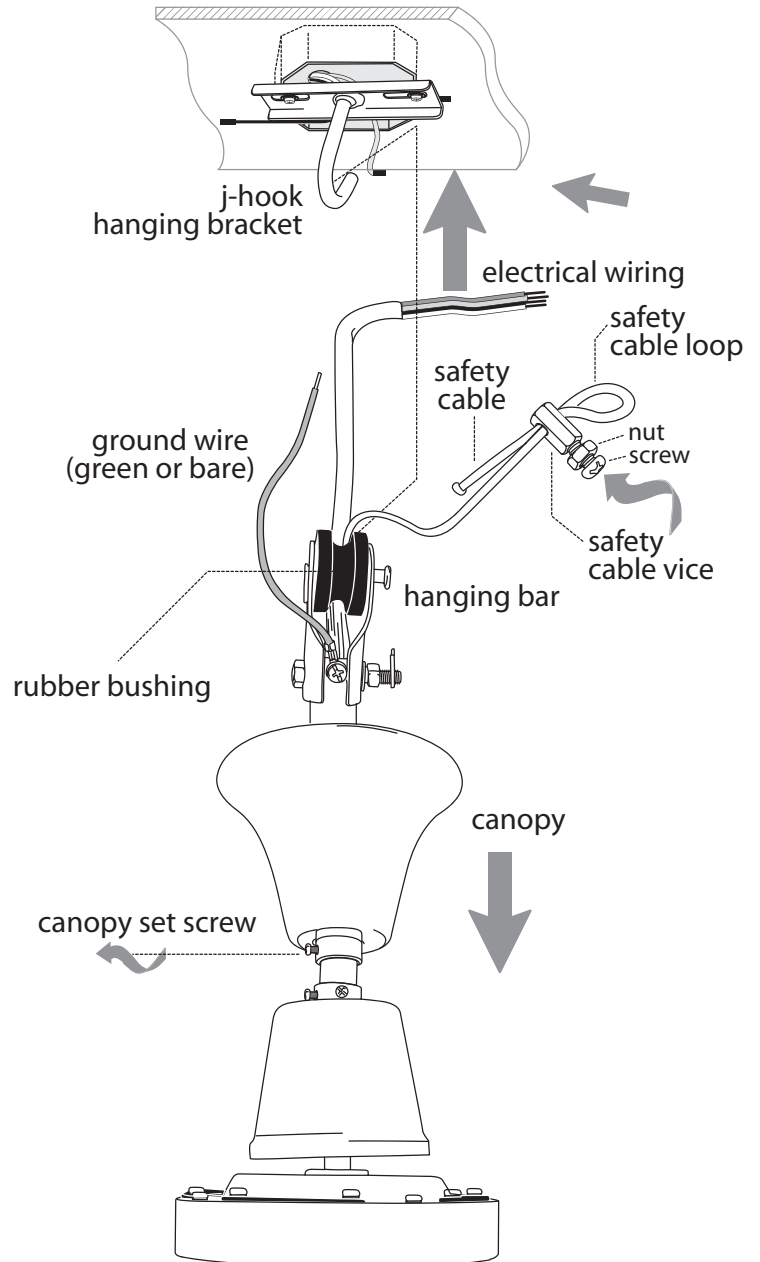

6. Wiring.

Important: Be sure outlet box is properly grounded or that a ground wire (**GREEN** or **Bare**) is present.

Make sure all electrical connections comply with Local Codes or Ordinances and the National Electrical Code. If you are unfamiliar with electrical wiring or if the wires in the house/building are different colors than those mentioned below, please consult with a qualified electrician.

Connect **BLACK** wire from fan to **BLACK** wire from ceiling. Connect **WHITE** wire from fan to **WHITE** wire from ceiling. Connect **GREEN** wire from fan to **BARE/GREEN** wire from ceiling. Use wire connectors provided when making connections.

* Wrap each wire connector separately with electrical tape as an extra safety measure. Turn spliced/taped wires upward and gently push these wires and wire connectors into outlet box.

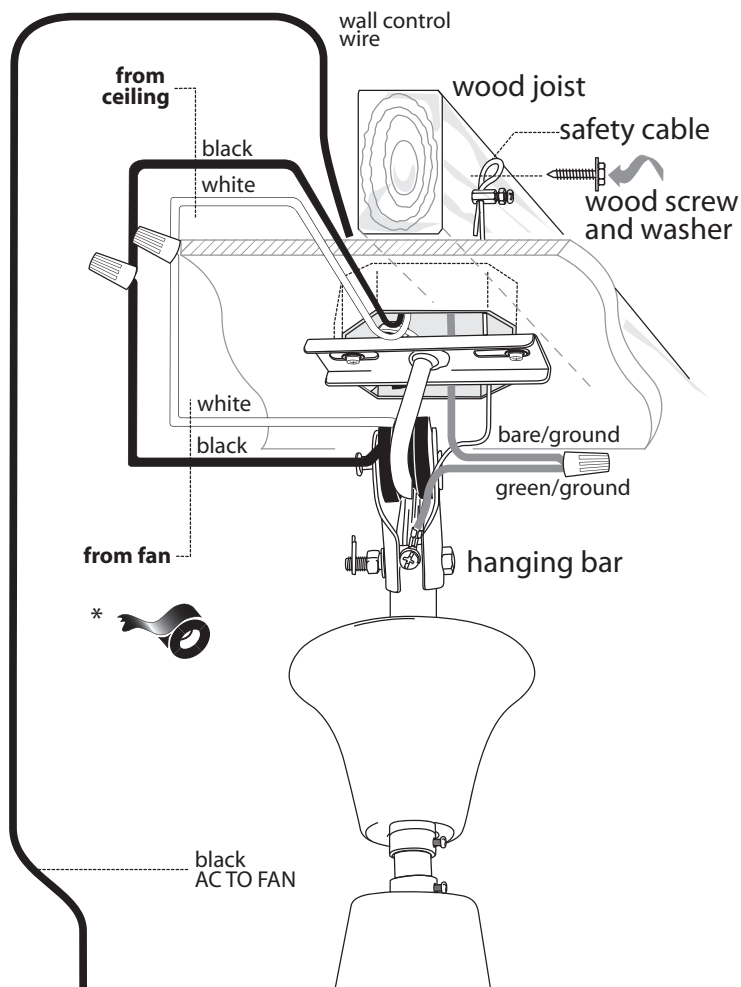

7. Wiring - Wall Control

Remove existing wall switch. Remove wall control back plate by removing 2 screws on the wall control—one on the top and one on the bottom. Secure wall control back plate to wall or structure with screws from existing wall switch.

Connect **BLACK** wire from wall control to **BLACK (AC TO FAN)** wire from wall. Connect **BLACK** wire from wall control to **BLACK (AC IN)** wire from wall. Use wire connectors provided when making connections.

* Wrap each wire connector separately with electrical tape as an extra safety measure. Turn spliced/taped wires upward and gently push these wires and wire connectors into back plate.

Re-attach wall control to back plate using the 2 screws that were previously removed.

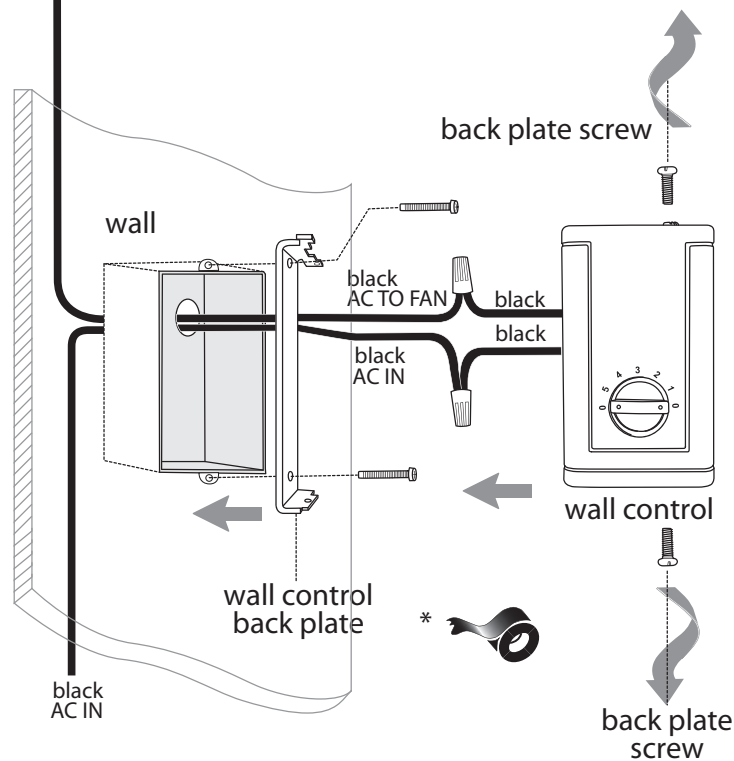

8. Canopy Assembly.

Lift canopy until it covers hanging bracket and touches ceiling. Tighten canopy set screw to secure canopy.

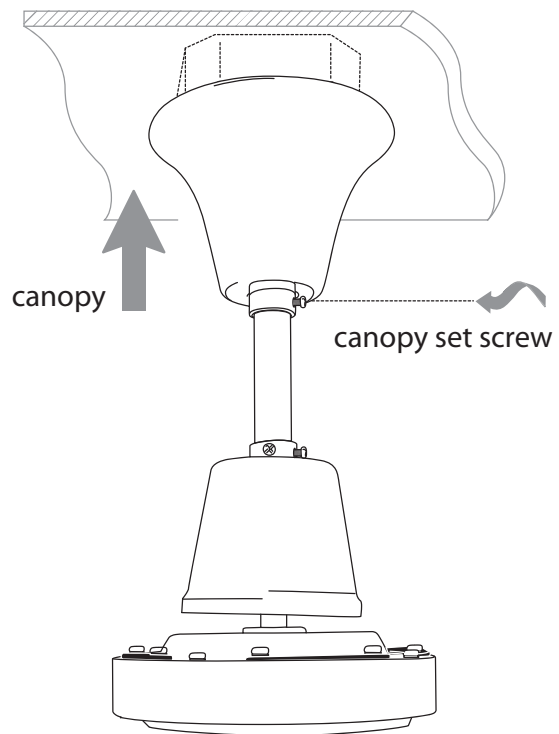

9. Blade Assembly.

Remove blade screws and washers from top of motor housing--leave rubber cushions intact.

Lower one of the blades over a rubber cushion and attach the blade with 2 of the washers and blade screws that were just removed, as shown. Tighten both blade screws securely. Repeat with the remaining blades.

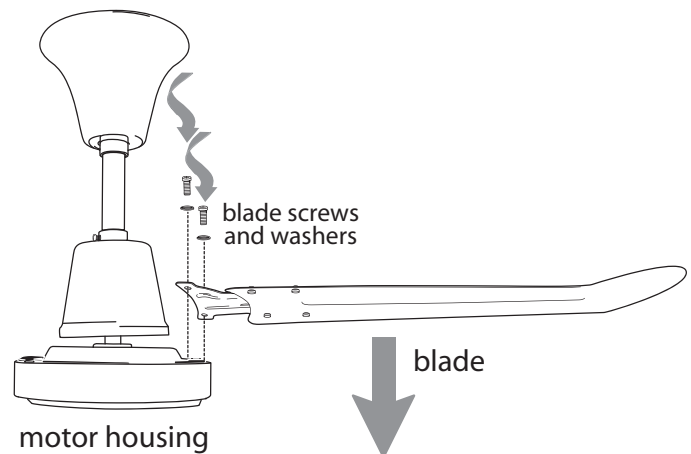

10. Wall Control Operation.

- 0** - turns fan OFF
- 1** - turns fan to LOW speed
- 2** - turns fan to MEDIUM-LOW speed
- 3** - turns fan to MEDIUM speed
- 4** - turns fan to MEDIUM-HI speed
- 5** - turns fan to HI speed

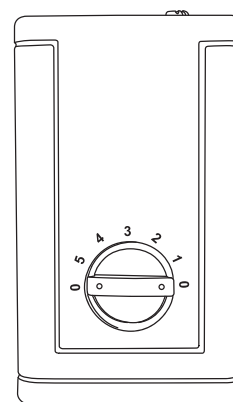

11. Testing Your Fan.

It is recommended that you test fan before finalizing installation. Restore power from circuit box. Test fan speeds with wall control. Start at the OFF ("0") position (no blade movement) and try each of the 5 different fan speeds.

If fan does not function, please refer to "Troubleshooting" section to solve any issues before contacting Customer Service.

Troubleshooting.

WARNING: Failure to disconnect power supply prior to troubleshooting any wiring issues may result in serious injury.

Problem: Fan fails to operate.

Solutions:

1. Check power to fan.
2. Check to be sure fan is wired properly.
3. Check to be sure wall control is wired properly.

Parts Replacement.

For parts and information, please refer to "Parts Inventory" on page 2.

Litex Customer Support:

1-800-527-1292

Warranty.

LITEX 15-YEAR LIMITED WARRANTY:

LITEX INDUSTRIES, LTD. warrants this fan to the original household purchaser for indoor use under the following provisions:

1-YEAR WARRANTY: LITEX INDUSTRIES, LTD. will replace or repair any fan which has faulty performance due to a defect in material or workmanship. Contact Litex Customer Service at **1-800-527-1292** to arrange for return of fan. Return fan, shipping prepaid, to Litex Industries, Ltd. We will repair or ship you a replacement fan, and we will pay the return shipping cost.

5-YEAR WARRANTY: LITEX INDUSTRIES, LTD. will repair or replace, at no charge to the original purchaser, any fan motor that fails to operate satisfactorily when failure results from normal use.

RETURN FAN MOTOR ONLY, shipping prepaid, to Litex Industries. We will repair or ship purchaser a replacement motor and Litex will pay the return shipping cost.

6 to 15-YEAR WARRANTY: LITEX INDUSTRIES, LTD. will repair the fan, at no charge to the original purchaser for labor only, if the fan motor fails to operate satisfactorily when failure results from normal use. Parts used in the repair will be billed to the purchaser at prevailing prices at time of repair.

The purchaser shall be responsible for all costs incurred in the removal, reinstallation and shipping of the product for repairs.

This warranty does not apply when damage from mechanical, physical, electrical or water abuse results in causing the malfunction. Deterioration of finishes or other parts due to time or exposure to salt air is specifically exempted under this warranty.

Neither Litex Industries nor the manufacturer will assume any liability resulting from improper installation or use of this product. In no case shall the company be liable for any consequential damages for breach of this, or any other warranty expressed or implied whatsoever. This limitation as to consequential damages shall not apply in states where prohibited.

