

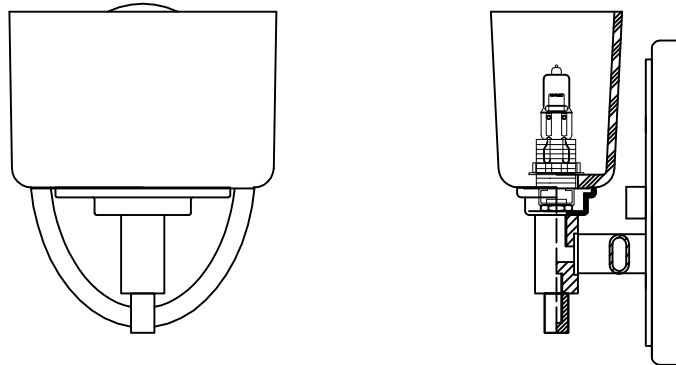

PRODUCT NAME: LOLA
ITEM NUMBER:9021

Please consult your electrician for Hang fixture and wiring.



Warnings:

G4 and G9 Xenon Bulbs

Caution: Xenon bulbs get very hot and may burn you. Always make sure bulbs are off for a minimum of 10 minutes before handling. Fixture may be dimmed using an electronic low voltage dimmer.

Bulb(included) :40 Watt G9 Xenon Frost

**PRODUCTS ARE NOT INENDED
FOR COMMERCIAL USE.**

MADE IN CHINA
Page 1 of (3)

IMPORTANT: Turn off power at the main fuse or circuit breaker box before starting installation



(A) Bracket

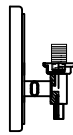

(B) Body



(C) Ball nut

Locate all hardware & components before discarding packaging

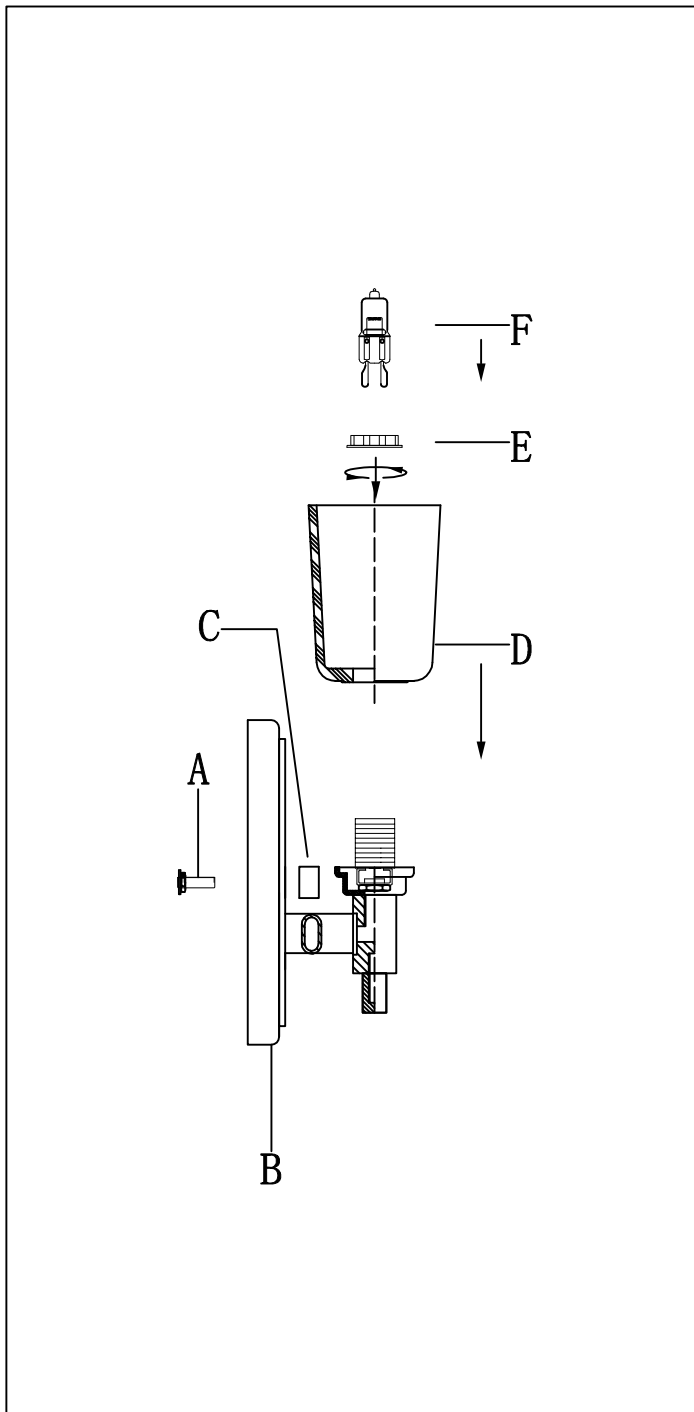

Fixture can only be installed up

1.)

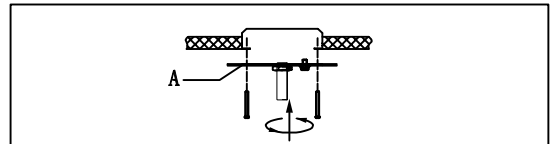

Step. 1: Remove mounting bracket(A) from fixture and install to electrical box.

2.)

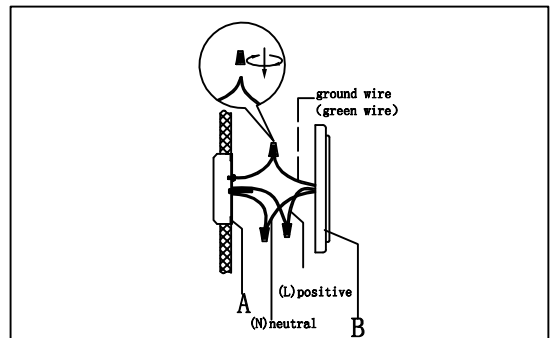

Step. 2: Wire fixture to wires in outlet box. Copper/Green wire is for Ground.

3.)

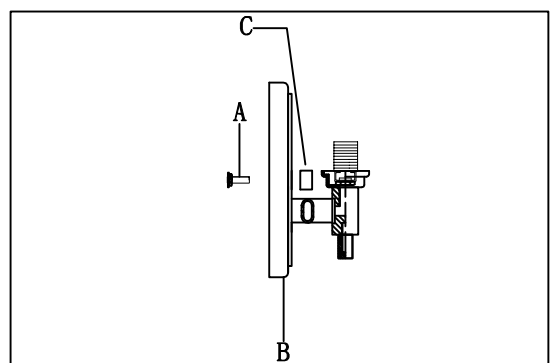

Step. 3: Install fixture to bracket(A) and tighten ball nuts (C) on the backplate to secure.

Cleaning & Care:

Clean with soft cloth and a mild detergent.
Do not use abrasive cleaner.

IMPORTANT: Turn off power at the main fuse or circuit breaker box before starting installation

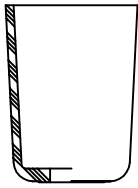

(D) Glass shade



(E) E27 Socket Ring



(F) Bulb

Locate all hardware & components before discarding packaging

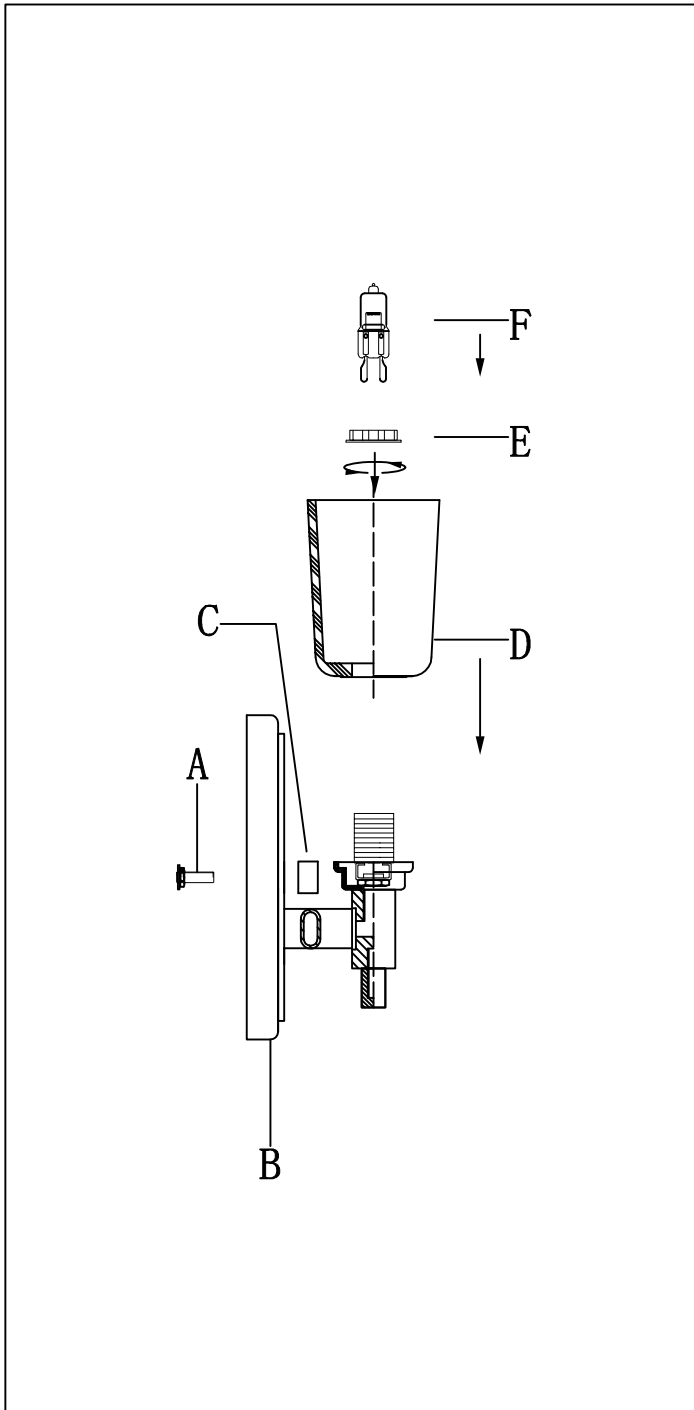

Fixture can only be installed up

4.)

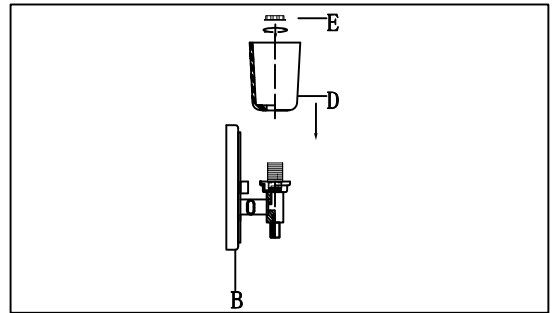

Step. 4: Place the GLASS shade (D) on the lamp body (C)

5.)

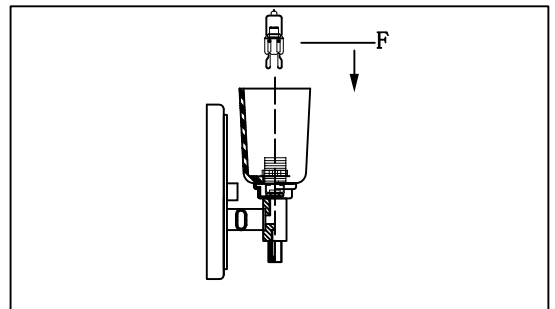

Step. 5: Install the bulb

Cleaning & Care:

Clean with soft cloth and a mild detergent.
Do not use abrasive cleaner.