

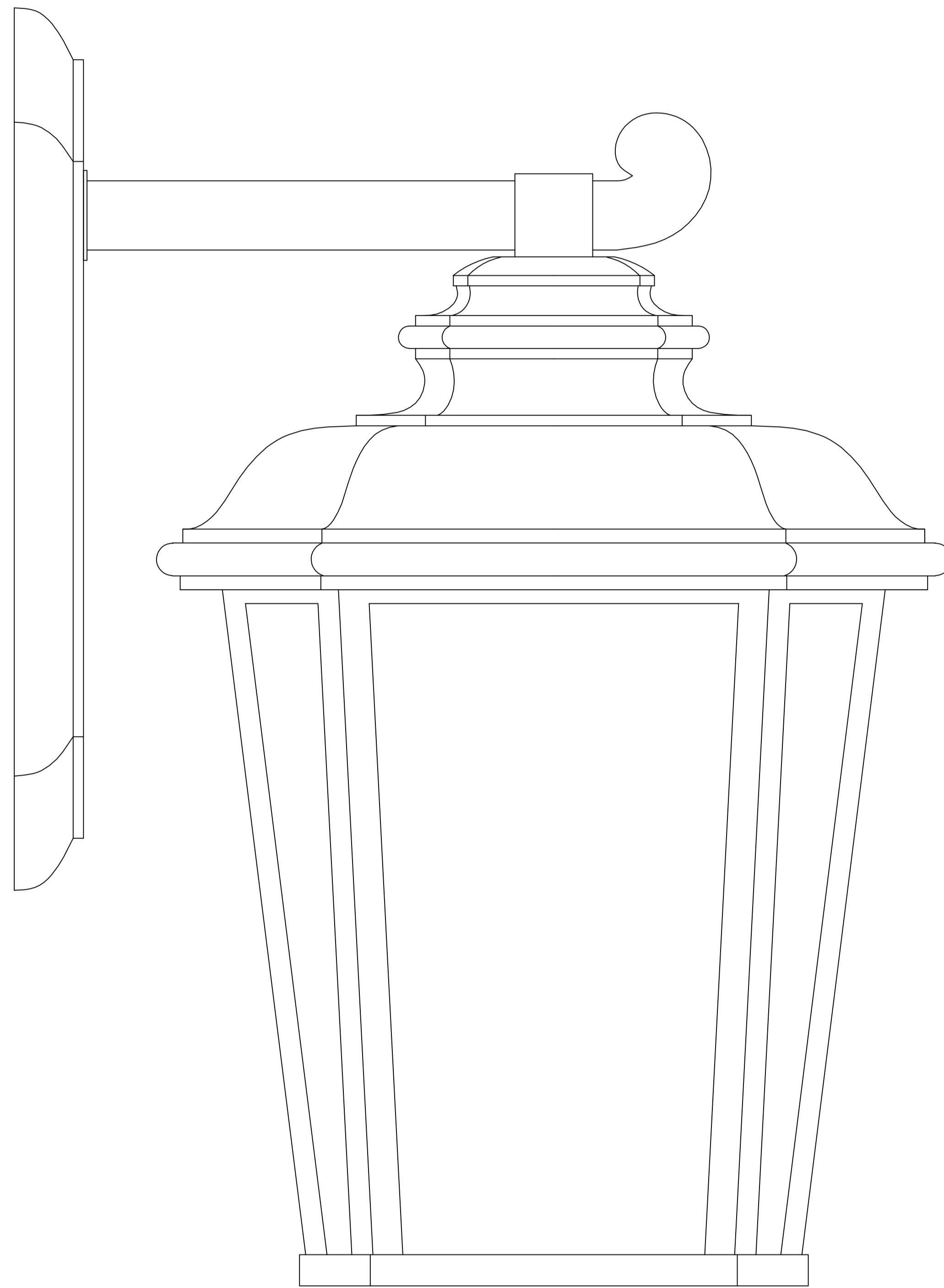

PRODUCT NAME: Radcliffe
ITEM NUMBER: 65642

Please consult your electrician for hanging fixture and wiring.



To prevent water intrusion, caulk around back-plate where fixture meets the wall using outdoor silicone sealant. Leave a small gap at the bottom to allow moisture to exit.

Bulb(included): 1×9W E26 LED

MADE IN CHINA



PRODUCT NAME: Radcliffe
 ITEM NUMBER: 65642

IMPORTANT: Turn off the power at the main fuse or circuit breaker box before starting installation.

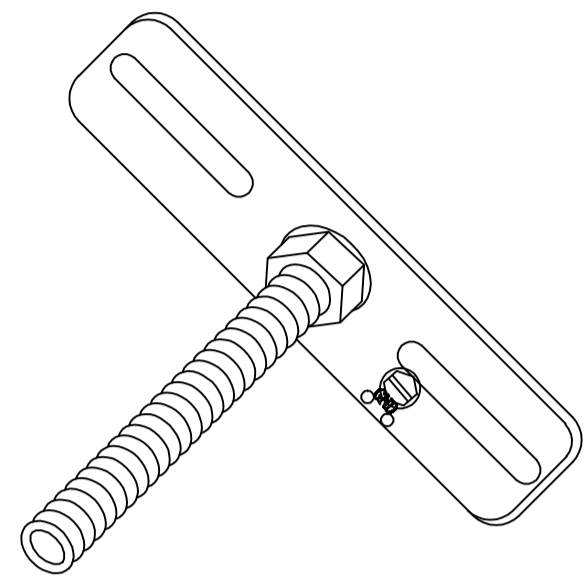

Bracket (A)

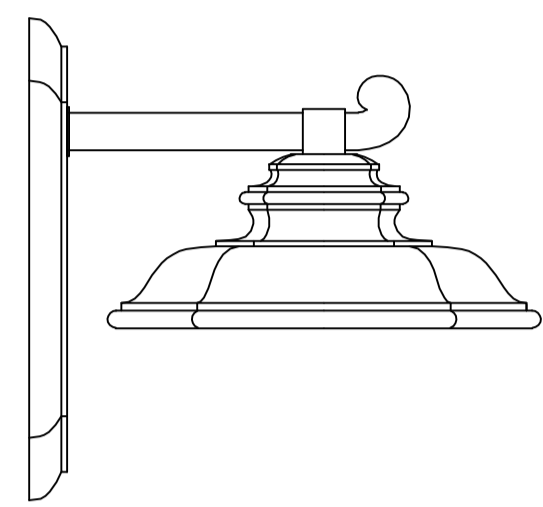

Fixture (B)

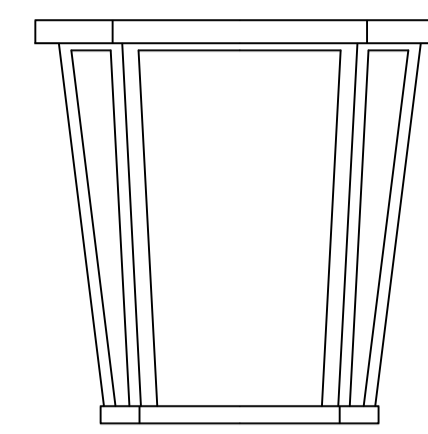

Cage (C)

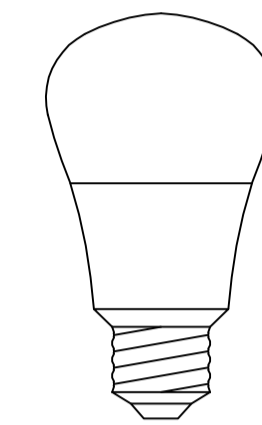

E26 LED Bulb (D)

Locate all hardware & components before discarding packaging

1.)

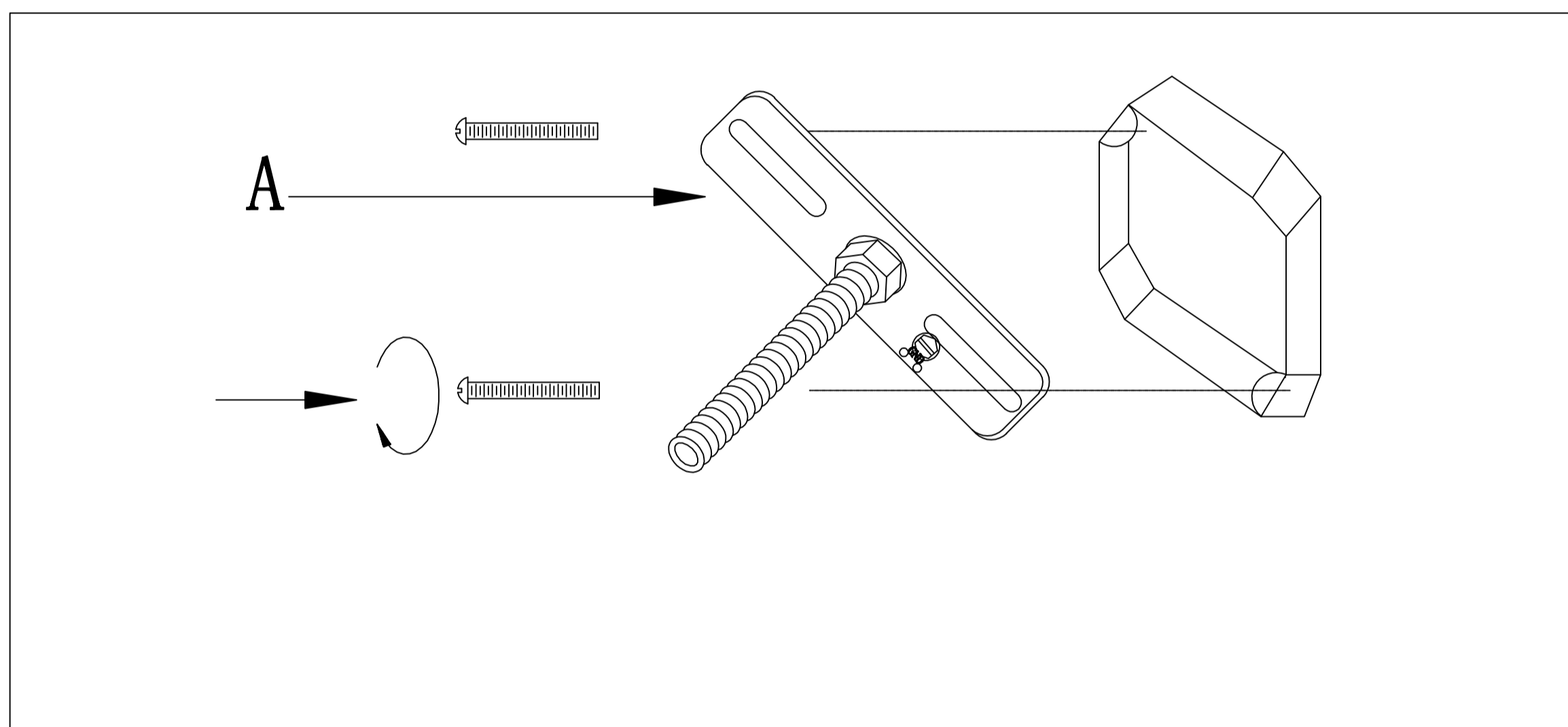

Step.1: Remove mounting bracket from fixture(B) and install to electrical box. then wire fixture to wires in outlet box. Copper wire is for Ground.

3.)

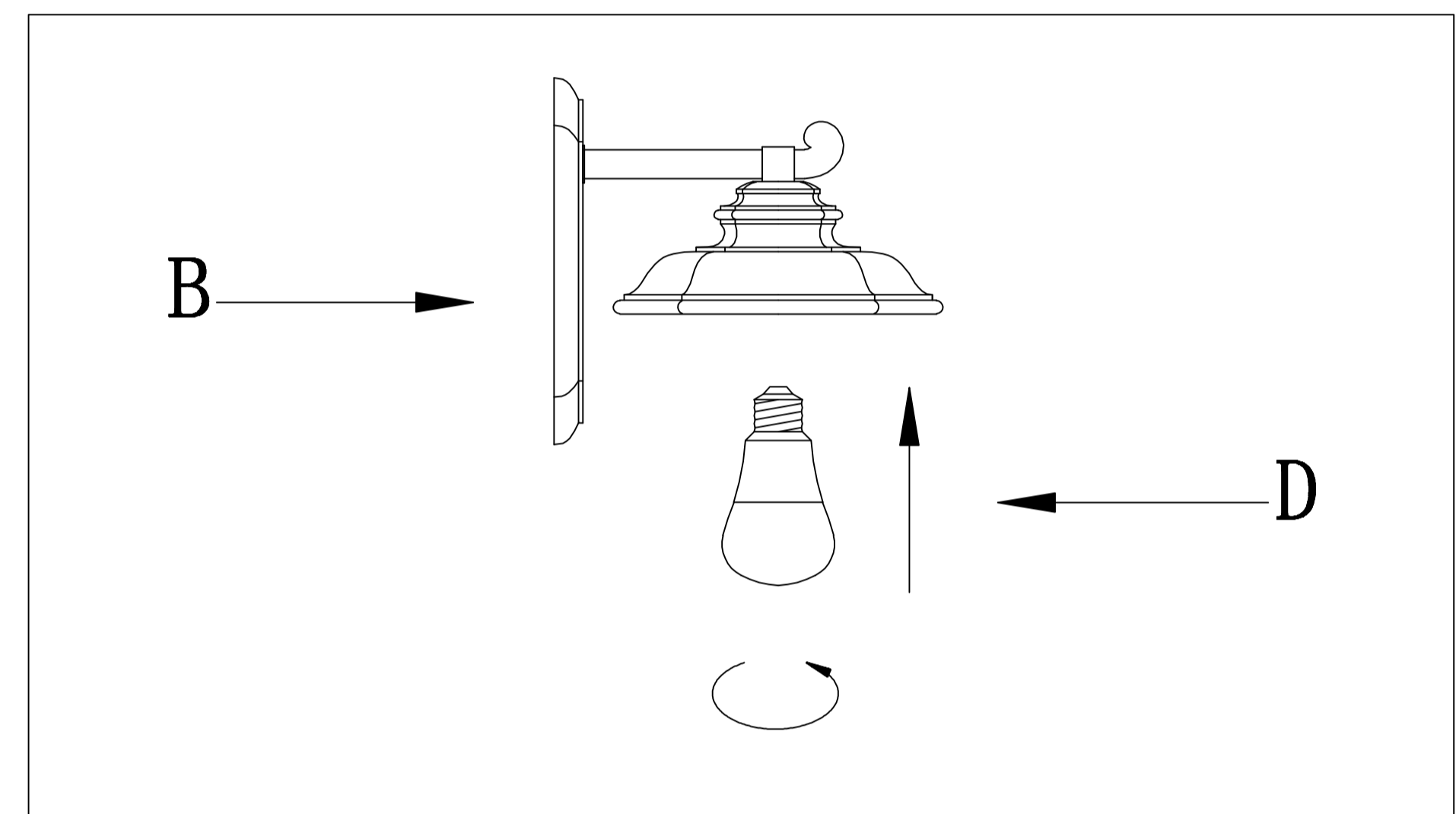

Step.3: Install E26 LED bulb(D)

2.)

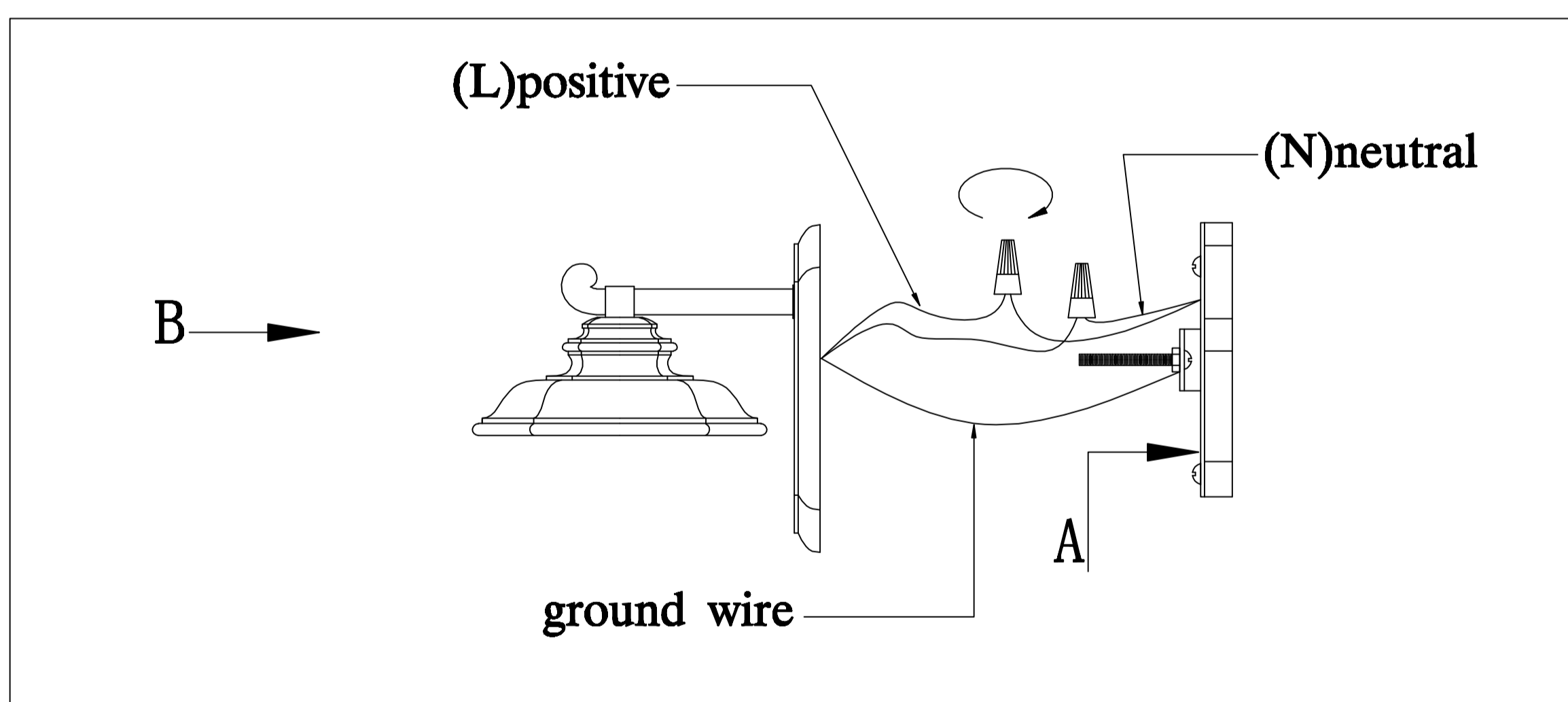

Step.2: Attach back plate to mounting bracket and tighten ball nuts so fixture meets wall. Caulk fixture where back plate meets the wall with silicone sealant.

4.)

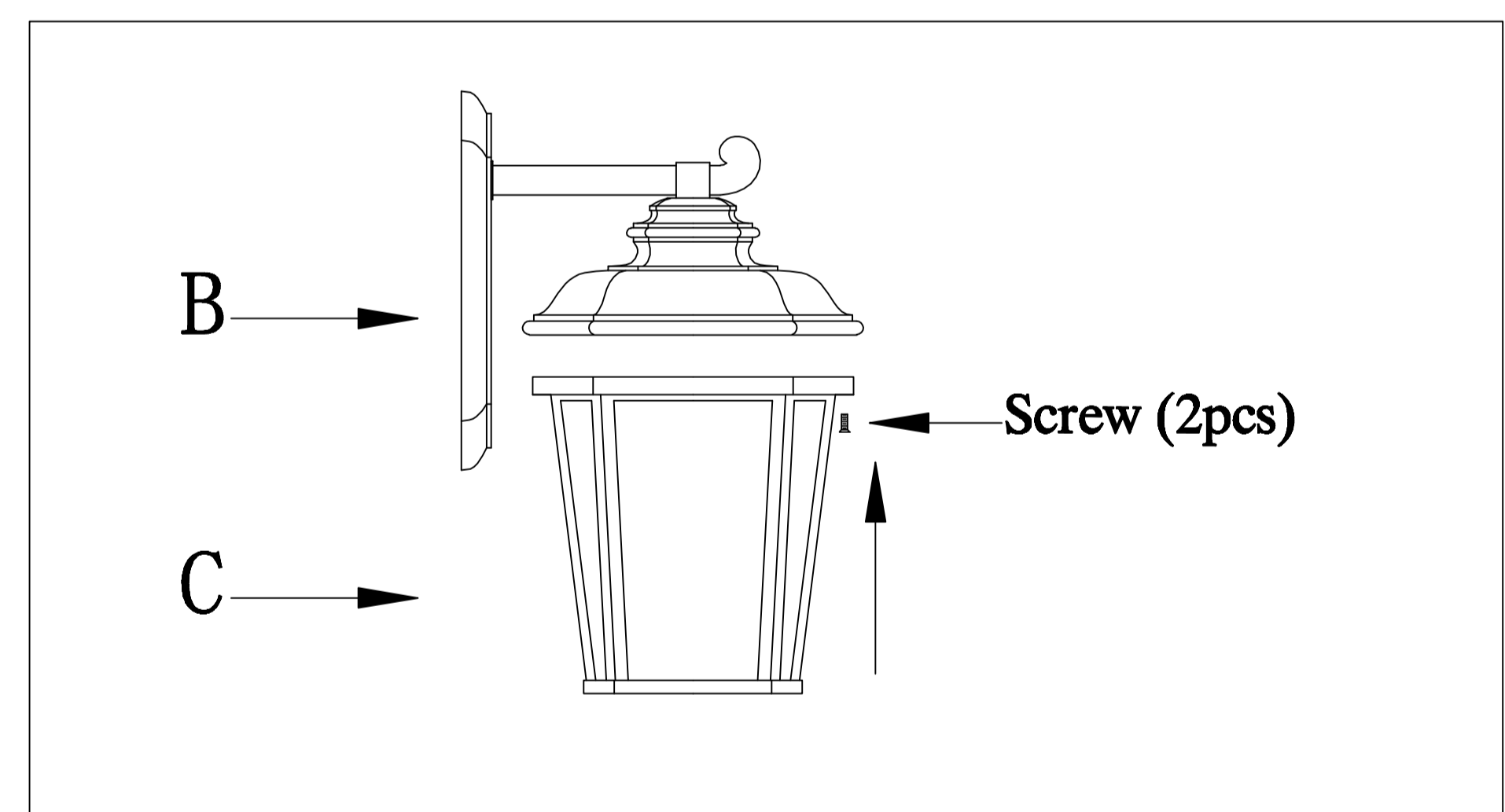

Step.4: Attach cage(C) to fixture , using screws.

Cleaning & Care:

Clean with soft cloth and a mild detergent.
 Do not use abrasive cleaner.

MADE IN CHINA