

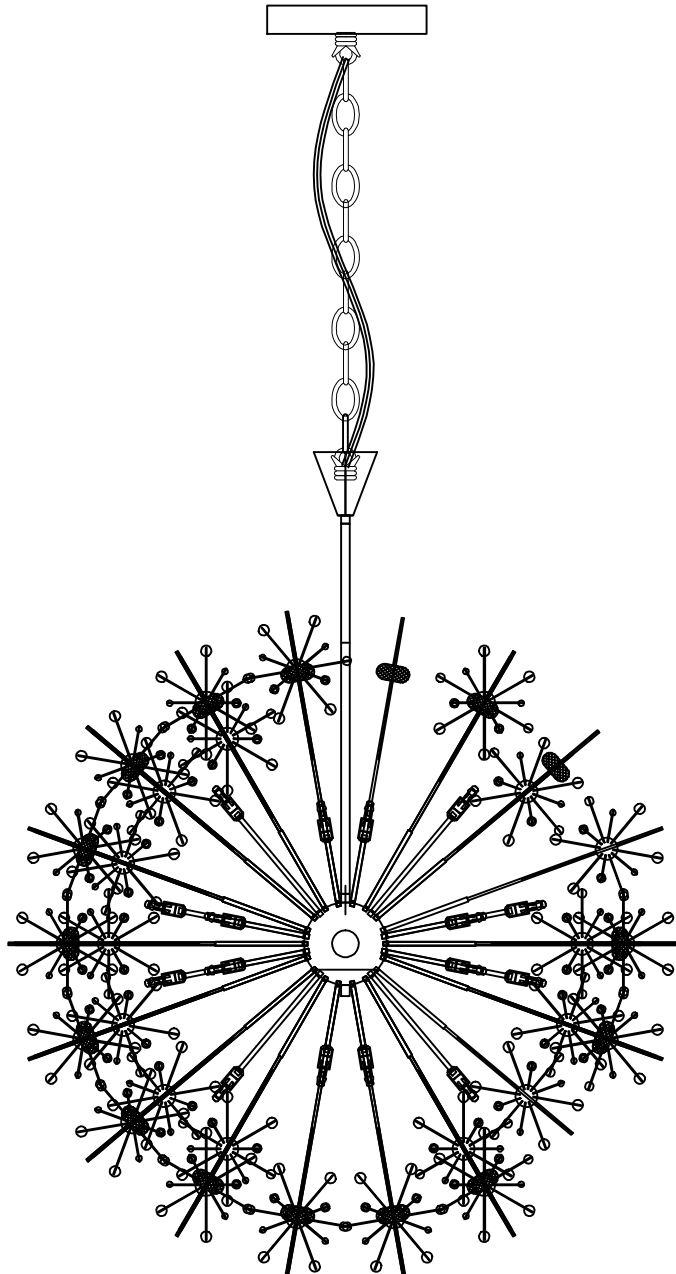

**PRODUCT NAME: Starfire 40-Light Chandelier**  
**ITEM NUMBER: 39747BCPC**



**Please consult your electrician for hanging fixture and wiring.**

**Light Source : 40 x G9 25W Bulb(Included)**

**Made in China / Hecho en China / Fabrique en China**

## Xenon Lighting

Before Getting Started	Antes de comenzar	Avant de commencer
Read the instructions carefully prior to assembling the product.	Lire attentivement les instructions avant d'assembler le produit.	Lea atentamente las instrucciones antes de ensamblar el producto.
When you open the package with a sharp tool like a cutter knife, be careful not to damage the components inside.	Lorsque vous ouvrez le paquet avec un outil pointu comme un couteau de coupe, veillez à ne pas endommager les composants à l'intérieur.	Cuando abra el paquete con una herramienta afilada como un cuchillo de corte, tenga cuidado de no dañar los componentes dentro.
Carefully remove all packaging materials and retain for future use.	Retire con cuidado todos los materiales de embalaje y consérvelos para usarlos en el futuro.	Retirez soigneusement tous les matériaux d'emballage et conservez-les pour un usage ultérieur.
Keep all hardware parts and packaging out of reach of small children.	Conservez toutes les pièces matérielles et les emballages hors de portée des petits enfants.	Mantenga todas las piezas y embalajes de hardware fuera del alcance de los niños pequeños.
Choose a clean, level, spacious assembly area. Avoid hard surfaces that may damage the product.	Choisissez une zone d'assemblage propre, de niveau et spacieuse. Évitez les surfaces dures qui pourraient endommager le produit.	Elija una zona de ensamblaje limpia, nivelada y espaciosa. Evite superficies duras que puedan dañar el producto.
Ensure that you have all required contents for complete assembly.	Assurez-vous que vous avez tous les contenus requis pour l'assemblage complet.	Asegúrese de que tiene todos los contenidos necesarios para el ensamblaje completo.
Take care when lifting. Assemble the product in close proximity to where you intend to position the item.	Prenez soin de soulever. Assemblez le produit à proximité de l'endroit où vous comptez positionner l'élément.	Tenga cuidado al levantar. Ensamble el producto cerca de donde tiene la intención de posicionar el artículo.
Do not over tighten the screws and bolts as this may damage the threads.	Ne serrez pas trop les vis et les boulons car cela pourrait endommager les filets.	No apriete excesivamente los tornillos y pernos, ya que esto puede dañar los hilos.
Do not let children play with this product.	No permita que los niños jueguen con este producto.	Ne laissez pas les enfants jouer avec ce produit.
<b>⚠ Risk of suffocation! Keep any packaging materials away from children.</b>	<b>⚠ ¡Riesgo de sofocación! Mantenga los materiales de embalaje lejos de los niños.</b>	<b>⚠ Risque d'asphyxie! Tenez tous les matériaux d'emballage à l'écart des enfants</b>

Lamp Care Instructions	Instrucciones de lámparas	Entretien de la lampe
Carefully read through the instruction sheet before assembly and using the product.	Lea cuidadosamente la hoja de instrucciones (si fue proporcionada) antes de armar y utilizar la lámpara.	Avant de procéder à l'assemblage et à l'utilisation de la lampe, lisez attentivement le mode d'emploi.
Caution there is a risk of shock. Disconnect from power source before assembling or cleaning.	Peligro por descarga eléctrica. Desconecte la lámpara de la fuente de electricidad antes de armarla o limpiarla.	Pour éviter tout risque d'électrocution, débranchez la lampe de la prise électrique avant de procéder à l'assemblage ou au nettoyage de la lampe.
<b>⚠ CAUTION: Xenon bulbs get very hot and may burn you. Always make sure bulbs are off for a minimum of 10 minutes before handling. Fixture may be dimmed using an electronic low voltage dimmer.</b>	<b>⚠ PRECAUCIÓN: las bombillas de xenón son muy calientes y pueden quemarse. Asegúrese siempre de que los bulbos estén apagados por un mínimo de 10 minutos antes de manipularlo. El accesorio puede atenuarse con un atenuador electrónico de baja tensión.</b>	<b>⚠ ATTENTION : Les ampoules xénon deviennent très chauds et peuvent vous brûler. Assurez-vous toujours que les ampoules sont éteintes pendant au moins 10 minutes avant de manipuler. Luminaire peut être atténué en utilisant un variateur électronique de tension faible.</b>
Only use the recommended bulb type and do not exceed the maximum wattage as it could cause fire.	Solo utilice el tipo de bombilla recomendado y no exceda la potencia eléctrica máxima ya que puede causar un incendio.	Afin d'éviter tout risque de feu, utilisez le type et la puissance d'ampoule recommandés.
Do not plug the product in if cord is torn or frayed.	No conecte la lámpara si el cable eléctrico está dañado o deshilachado.	Ne branchez pas la lampe si son cordon d'alimentation est déchiré ou effiloché







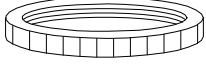

Cleaning & Maintenance	Limpieza y mantenimiento	Nettoyage et maintenance
On polished finishes, often using talc powder reduces the appearance of fingerprints and other smudges.	En acabados pulidos, a menudo usando polvo de talco reduce la aparición de huellas dactilares y otras manchas.	Sur les finitions polies, souvent en utilisant la poudre de talc réduit l'apparence des empreintes digitales et d'autres taches.
For respective shade surfaces, use the appropriate cleansers, i.e. glass cleaner, acrylic polish, and wood polish.	Para las respectivas superficies de sombra, utilice los limpiadores apropiados, es decir, limpiador de vidrio, esmalte acrílico y pulido de madera.	Pour les surfaces d'ombrage respectives, utilisez les nettoyeurs appropriés, c'est-à-dire le nettoyeur pour vitres, le Vernis acrylique et le vernis à bois.
Clean with soft cloth and a mild detergent. DO not use abrasive cleaner.	Utilice un trapo limpio, suave y seco que no raye ni manche la superficie cuando quite el polvo.	Nettoyer avec un chiffon doux et un détergent doux. N'utilisez pas de nettoyeur abrasif.
Periodically (every 90 days) make sure that the screws are fully tightened.	Períodicamente (cada 90 días) asegúrese de que los tornillos estén bien apretados.	Périodiquement (tous les 90 jours), assurez-vous que les vis sont bien serrées.
Prolonged exposure to heat sources may cause glazing, melting and scorching, or even cause color to fade.	La exposición prolongada a las fuentes de calor causa cristalización, derretimiento, quemadura y decoloración del tapizado.	Si le tissu subit une exposition prolongée aux sources de chaleur, il pourrait commencer à reluire, à roussir, à s'estomper ou même à se décolorer.

# EN Contents

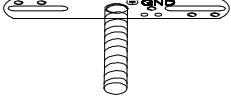
Before getting started, ensure the package contains the following components:

Antes de comenzar, asegúrese de que el paquete contenga los siguientes componentes:

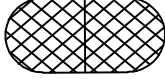
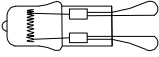
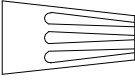
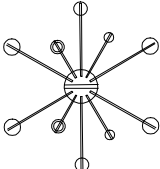
Avant de commencer, assurez-vous que le paquet contient les composants suivants:

<p><b>(A)</b></p>  <p>Fixture</p>	<p>X1</p>	<p><b>(H)</b></p>  <p>Threaded Ring</p>	<p>X1</p>	<p><b>(I)</b></p>  <p>Long Stem (With Red color)</p>	<p>X52</p>
<p><b>(B)</b></p>  <p>Mounting Bracket</p>	<p>X1</p>	<p><b>(J)</b></p>  <p>Long Stem (With Green Color)</p>	<p>X32</p>	<p><b>(K)</b></p>  <p>Short Stem (With Blue color)</p>	<p>X20</p>
<p><b>(C)</b></p>  <p>Anchor Bolts</p>	<p>X4</p>	<p><b>(L)</b></p>  <p>End caps</p>	<p>X40</p>	<p><b>(M)</b></p>  <p>Beveled Crystal</p>	<p>X104</p>
<p><b>(D)</b></p>  <p>G9 Bulb</p>	<p>X1</p>	<p><b>(F)</b></p>  <p>Wire nuts</p>	<p>X3</p>	<p><b>(G)</b></p>  <p>Spoke Ball</p>	<p>X32</p>
<p><b>(E)</b></p>  <p>Canopy</p>	<p>X72 set</p>				

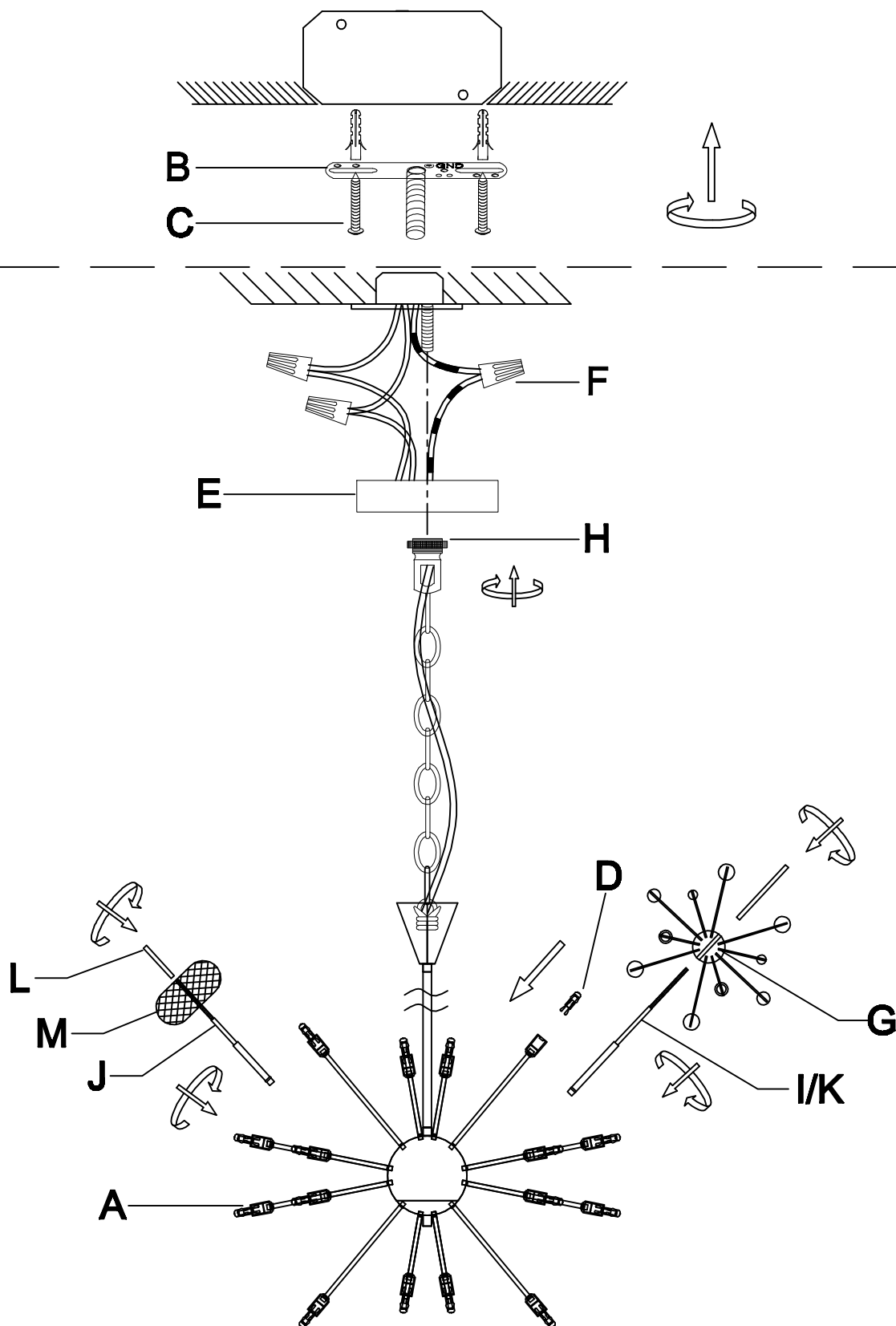

**Install top loop to canopy and attach appropriate amount of chain to loop to achieve desired mounting height. Thread wire through every 3rd loop of chain. Remove ring from loop and slide down chain. Place canopy onto chain and let slide to top of fixture. Install nipple and cross bar into top of chain loop.**

**Install color coded stems into corresponding colored threaded hole.  
 Install spoke balls onto end of red and blue stems and secure with cap stem.  
 Install beveled crystal onto end of green stems and secure with cap stem.**

# Model: 39747BCPC Crystal Diagram

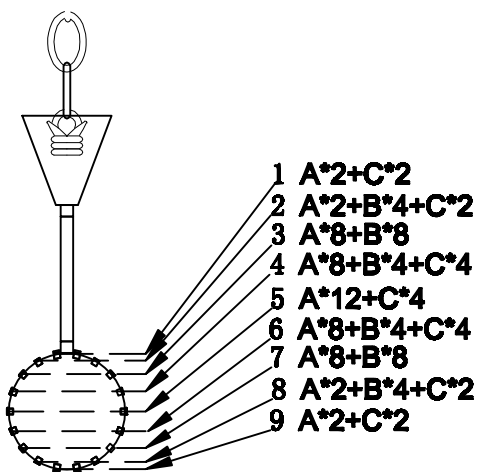
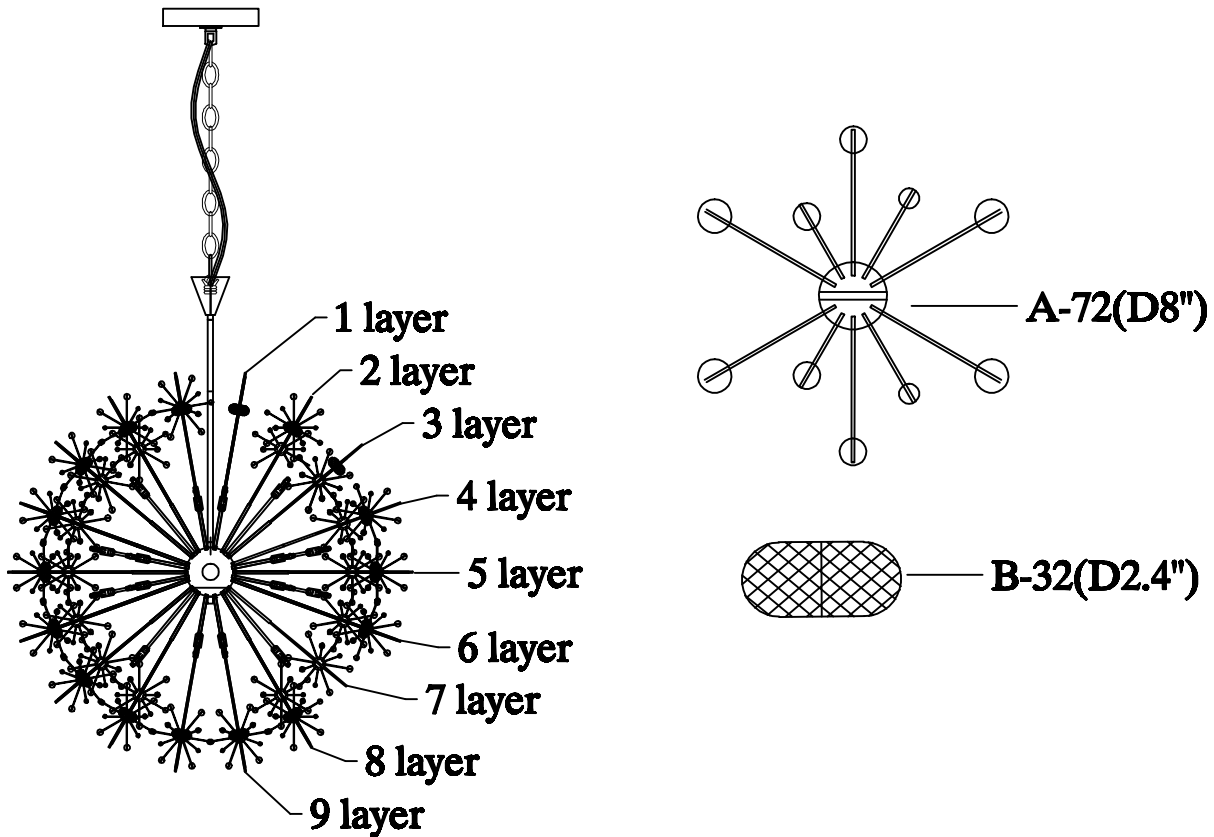

1 layer 	2 layer 	3 layer 
4 layer 	5 layer 	6 layer 
7 layer 	8 layer 	9 layer 

NO.	Color	MAXIM#	Q'ty	Length	Component
A	Red	ARM39747PC-A	52	16.34"	Spoke ball
B	Green	ARM39747PC-B	32	16.34"	Beveled crystal
C	Blue	ARM39747PC-C	20	12.6"	Spoke ball

# Model: 39747BCPC

## Crystal Diagram

**A-Red stem:ARM39747PC 52pcs L16.34"**

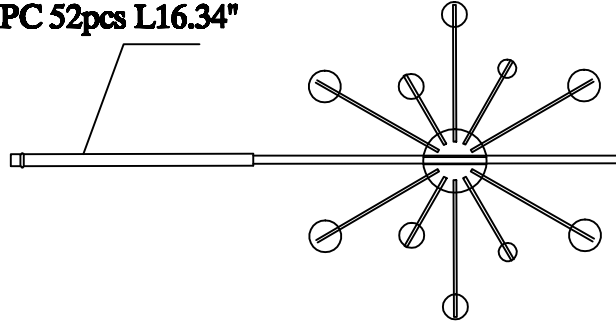

**B-Greem stem:ARM39747PC-A 32pcs L16.34"**

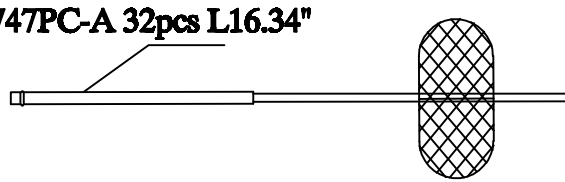

**C-Blue stem:ARM39747PC-B 20pc L12.6"**

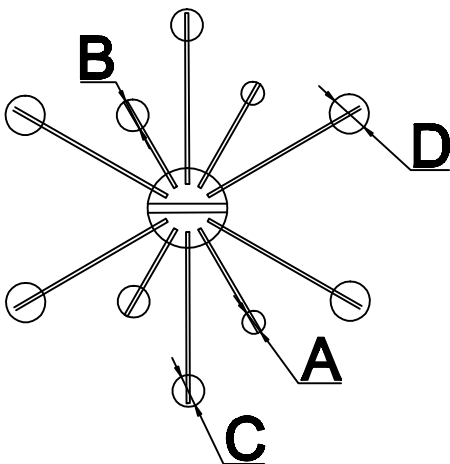
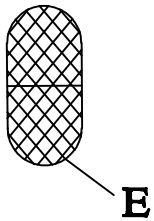
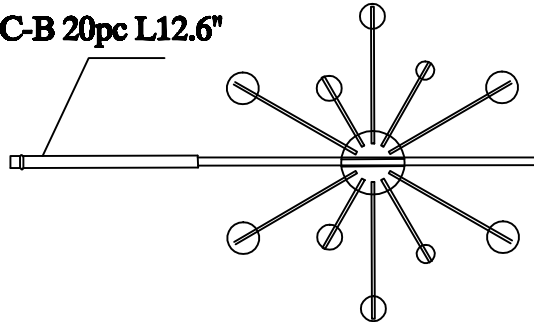

NO.	MAXIM#	Q'ty	Size
A	CJE39740-A	216	D0.5"
B	CJE39740-B	864	D0.55"
C	CJE39740-C	504	D0.7"
D	CJE39740-D	360	D0.8"
E	CRB39740	32	W2.35"*H1.2"