

1. Lay out glass by row beginning with bottom row 1. Glass is attached to cage by simply inserting hook onto horizontal bar and pull towards you until it locks.
2. Begin on bottom row 1, Space A and work counter clockwise until each row is complete. **Please note that enclosed diagram is a suggested layout. It is not critical to install exact. Glass size will vary so sometimes installing a piece on the next row down allows glass to stand more upright.**
3. Extra glass is supplied so if there is left over do not be concerned. If you can install extra on frame do so.

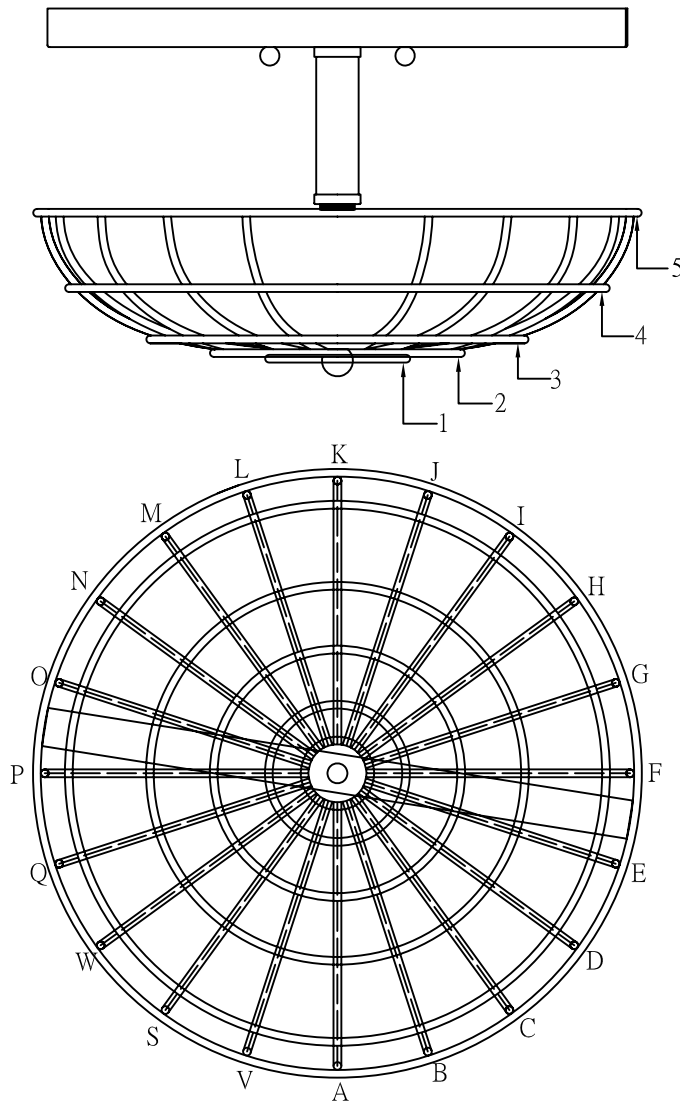

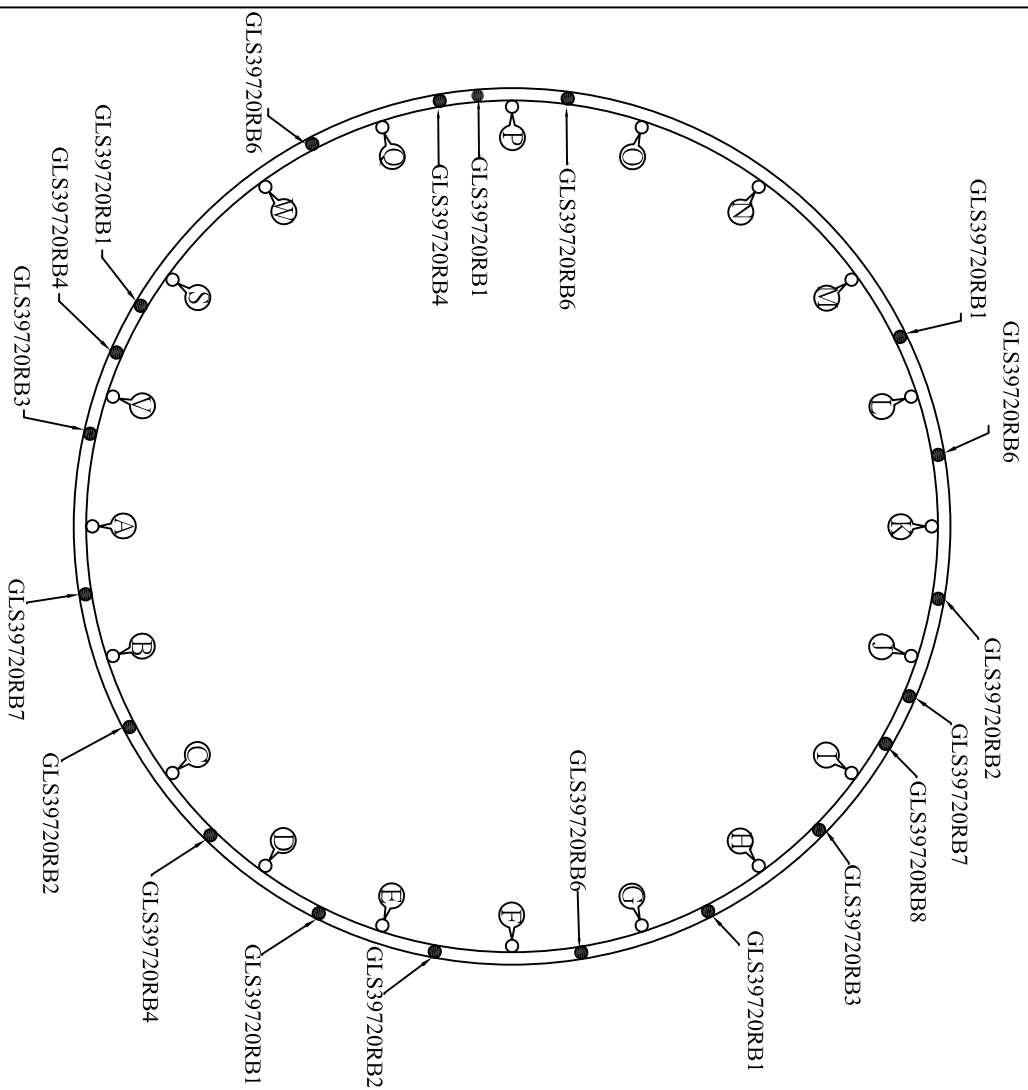

(4)

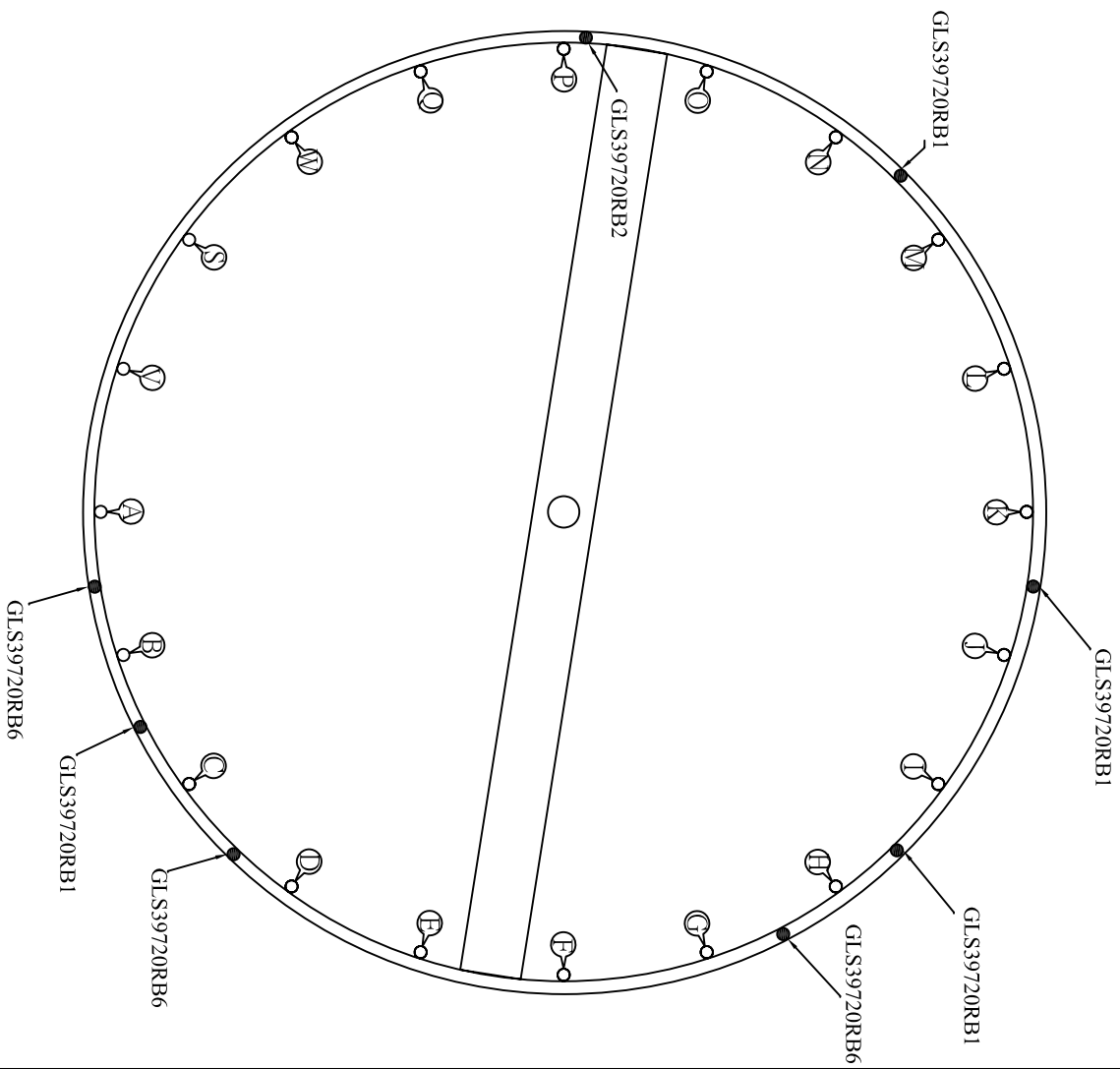

(5)

RB=Rootbeer finish WT=White finish

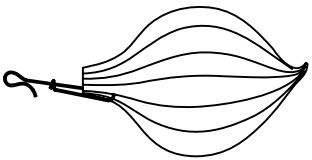

GLS39720RB1

Glass size: 3. "W*4.25"H

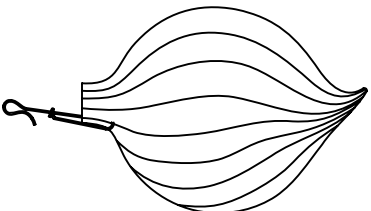

GLS39720RB3

Glass size: 4.25"W*6.25"H

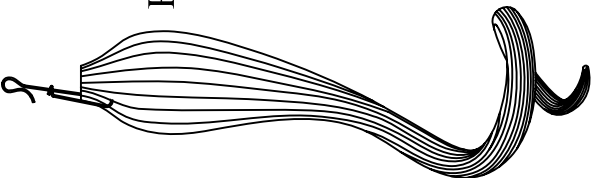

GLS39720RB4

GLS39720WT4

Glass size: 2.5"W*10.5"H

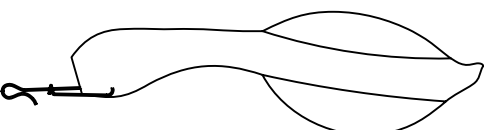

GLS39720RB7

Glass size: 1.5"W*8.75"H



GLS39720RB8

Glass size: 1.5"W*11.5"H

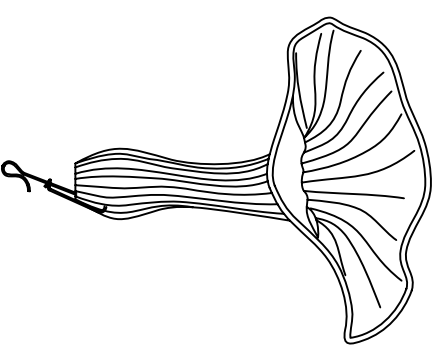

GLS39720RB9

Glass size: 1.5"W*7.5"H

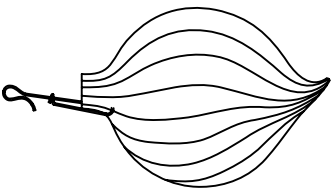

GLS39720RB2

Glass size: 3.75"W*5.25"H

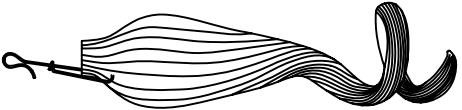

GLS39720RB6

Glass size: 2"W*7.75"H