

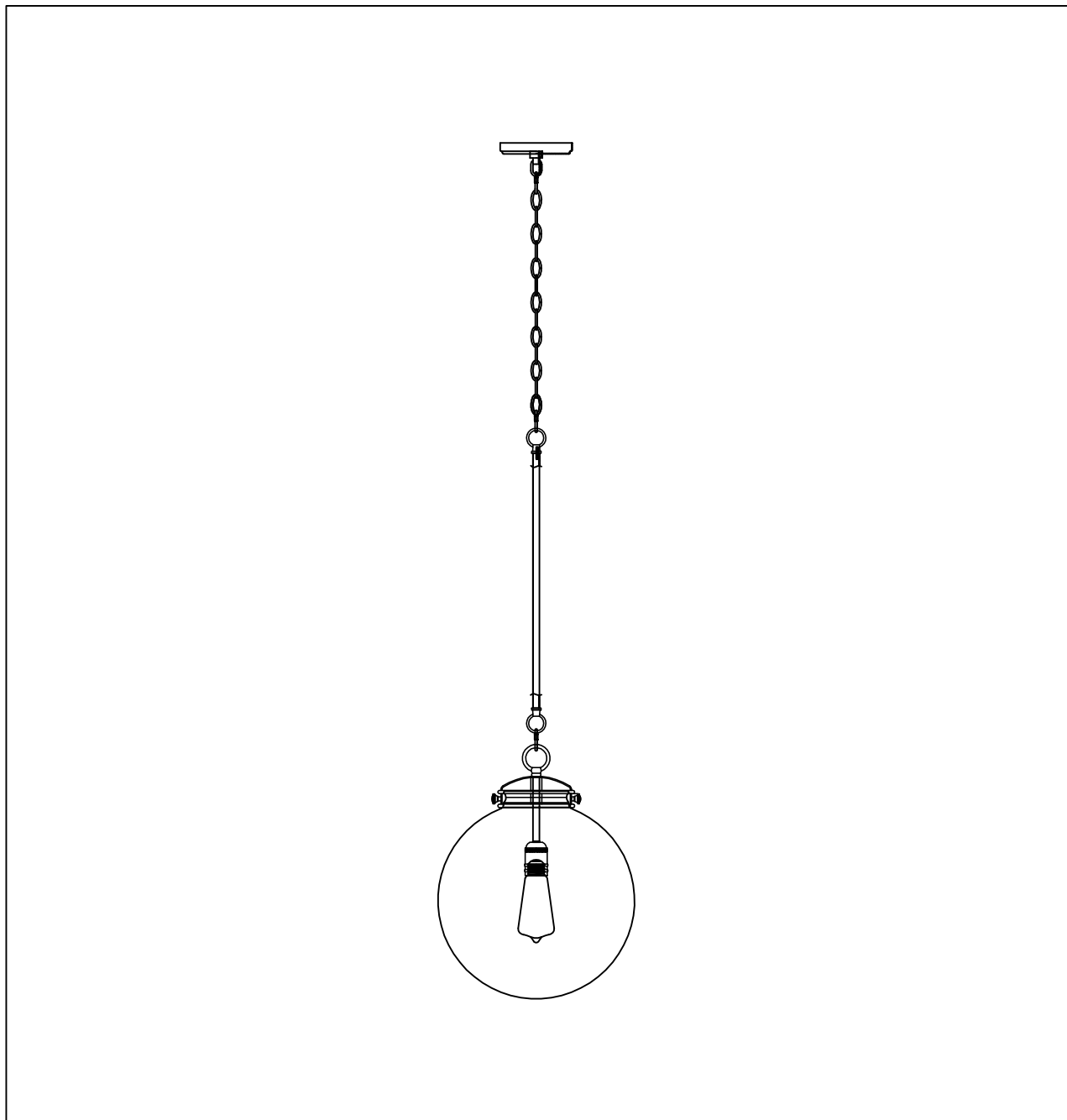

PRODUCT NAME: Retro
ITEM NUMBER: 25182

Please consult your electrician for hanging fixture and wiring.



Bulb(not included):1 Edison-style bulbs recommended

IMPORTANT: Turn off power at the main fuse or circuit breaker box before starting installation



(A) Bracket

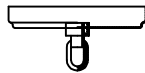

(B) Canopy

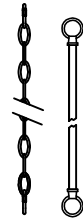

(C) Stem and Chain

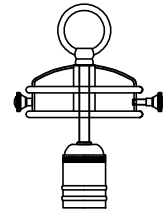

(D) Body

Locate all hardware & components before discarding packaging

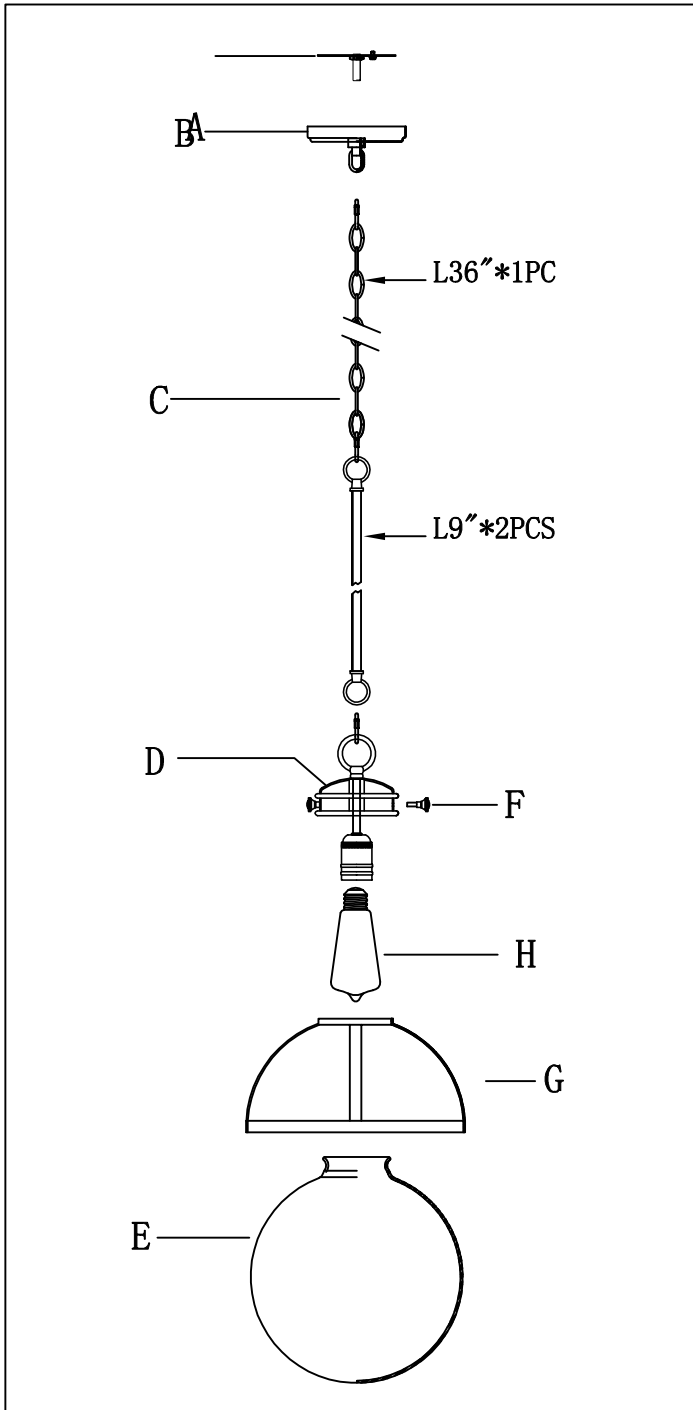

1.)

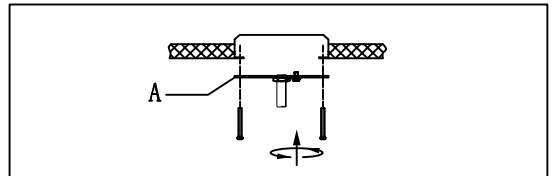

Step. 1: Remove mounting bracket(A) from fixture and install to electrical box.

2.)

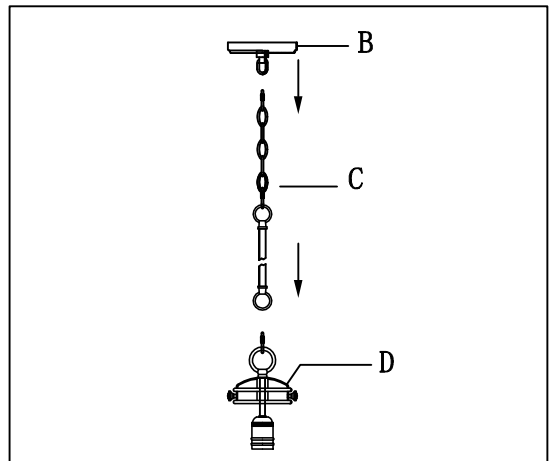

Step. 2: Attach appropriate amount of chain to loop to achieve desired mounting height. Thread wire through every 3rd loop of chain.

3.)

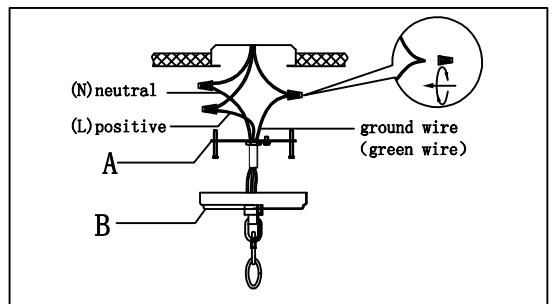

Step. 3: remove ring from loop and slide down chain. Place canopy onto chain and let slide to top of fixture. install nipple and cross bar into top of chain loop. Wire fixture to wires in outlet box. Copper wire is for Ground.

Cleaning & Care:

Clean with soft cloth and a mild detergent.
Do not use abrasive cleaner.

IMPORTANT: Turn off power at the main fuse or circuit breaker box before starting installation

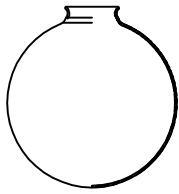

(E) Shade



(F) Lock nut

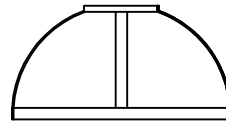

(G) The optional parts of shade



(H) Bulb

Locate all hardware & components before discarding packaging

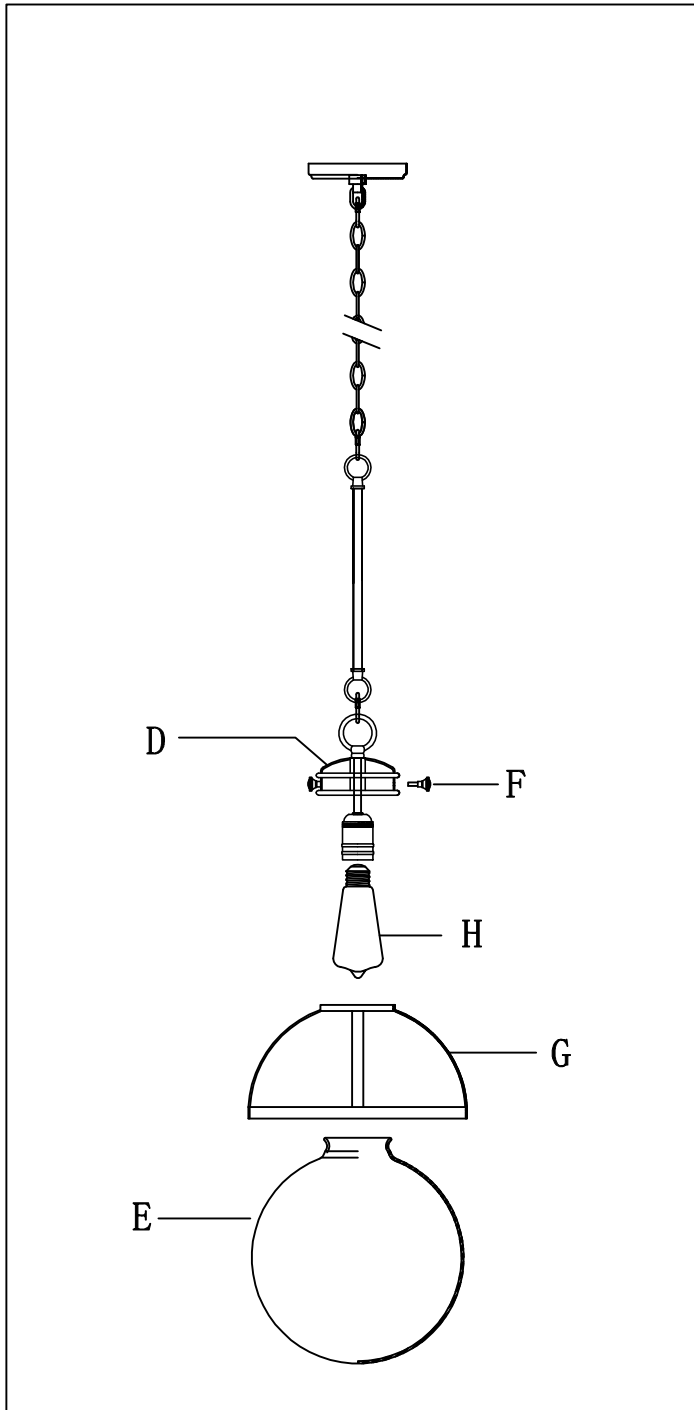

4.)

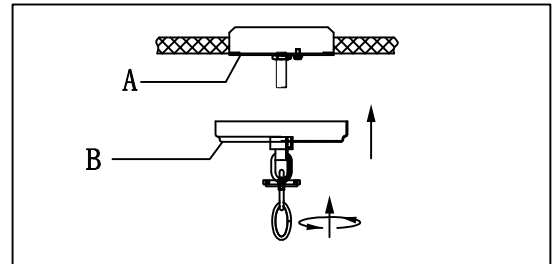

Step 4: Pull canopy through screw ring up chain to ceiling and tighten securely.

5.)

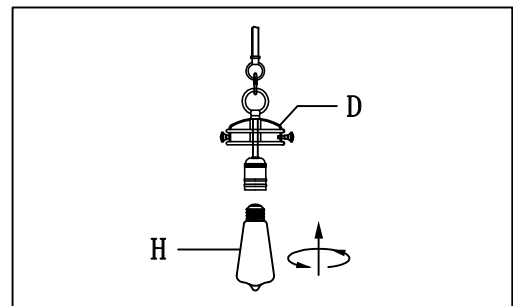

Step 5: Install the bulb

6.)

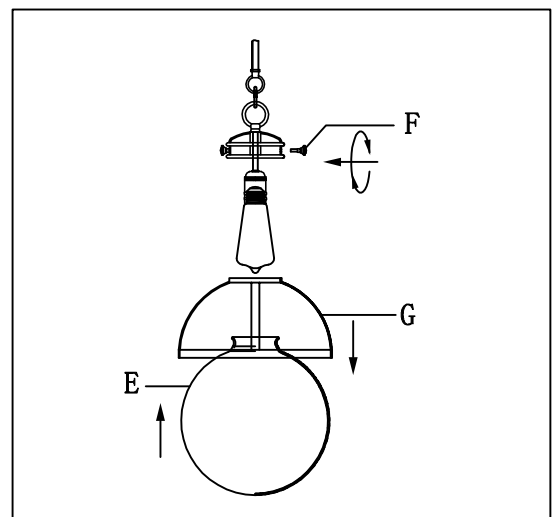

Step 6: Attach optional decorative frame (G) and use lock screws (F) to secure glass to fixture.

Cleaning & Care:

Clean with soft cloth and a mild detergent. Do not use abrasive cleaner.