

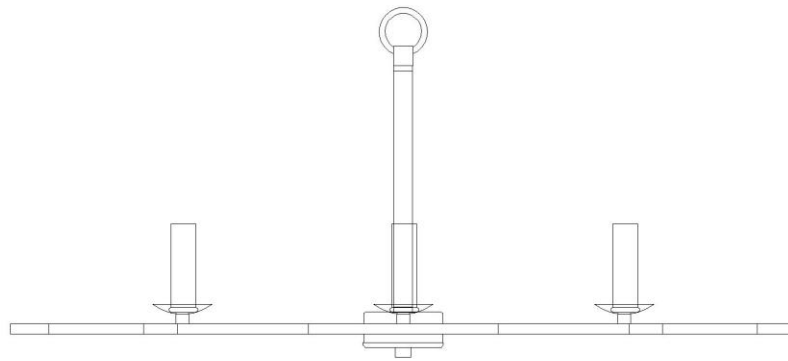

PRODUCT NAME: Helix 6-Light Chandelier
ITEM NUMBER: 24739BZF

Please consult your electrician for hanging fixture and wiring.



Bulb (not included):6*60w E12 Candelabra Bulbs

PRODUCTS ARE NOT INENDED
FOR COMMERCIAL USE.

MADE IN CHINA
Page 1 of (2)

IMPORTANT: Turn off the power at the main fuse or circuit breaker box before starting installation

Locate all hardware & components before discarding packaging

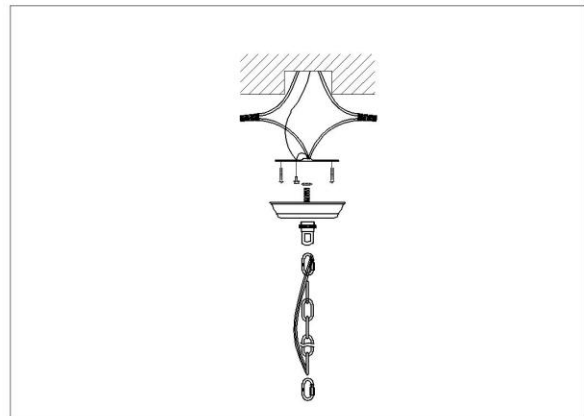
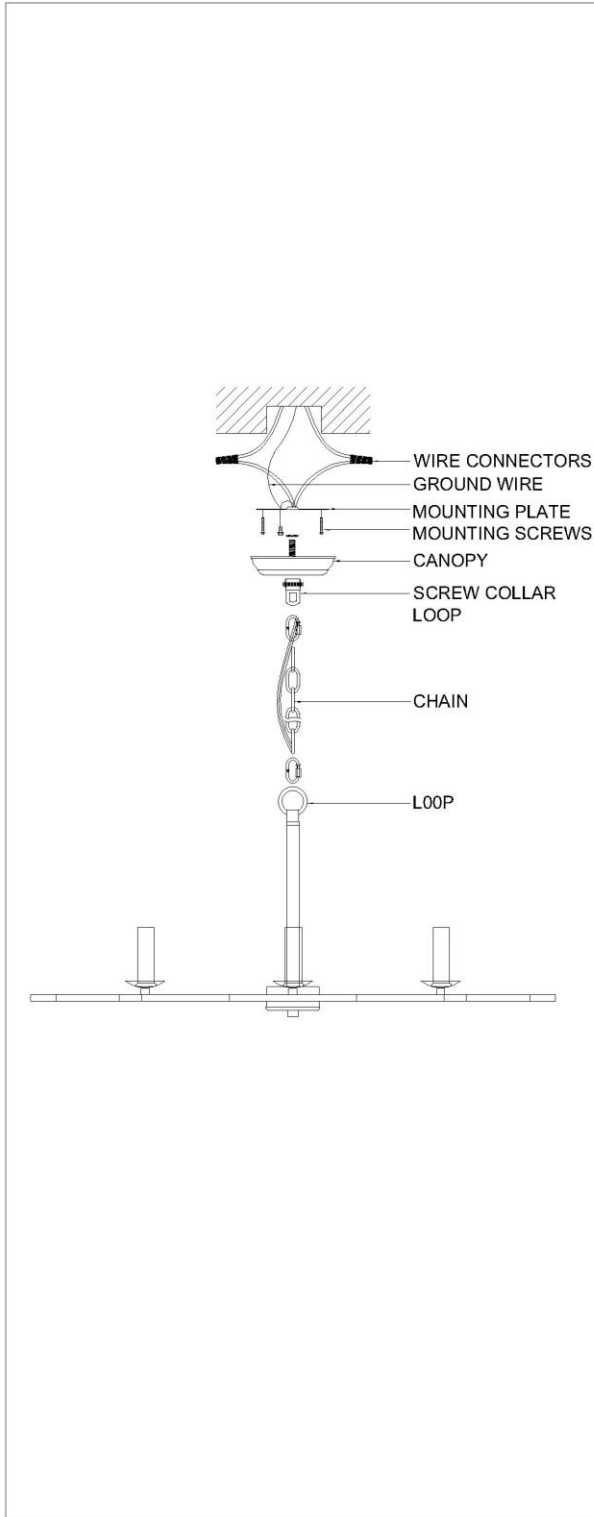

1. Remove mounting bracket from fixture and install to electrical box.
2. Attach appropriate amount of chain to loop to achieve desired mounting height. Thread wire through every 3rd loop of chain.
3. Remove screw ring from collar loop and slide down chain. Place canopy onto chain. Install nipple and cross bar into top of chain loop.
4. Wire fixture to wires in outlet box. Positive to black supply wire, neutral to white supply wire. Silver wire is for Ground.
5. Pull canopy through screw ring up chain to ceiling and tighten securely.

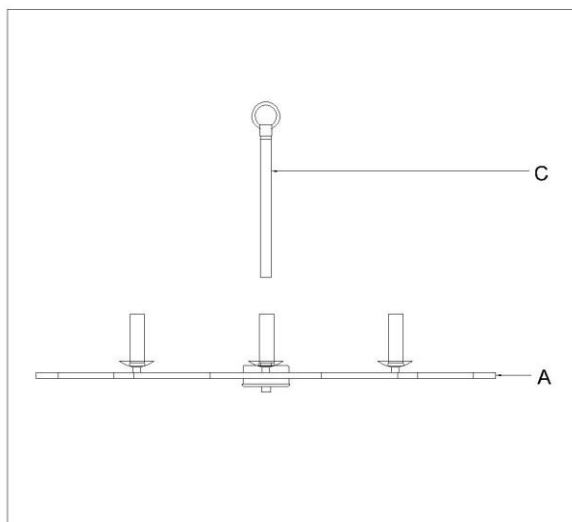

6. Secure center stem (C) to fixture (A).
7. Install max 60W candelabra bulbs.