

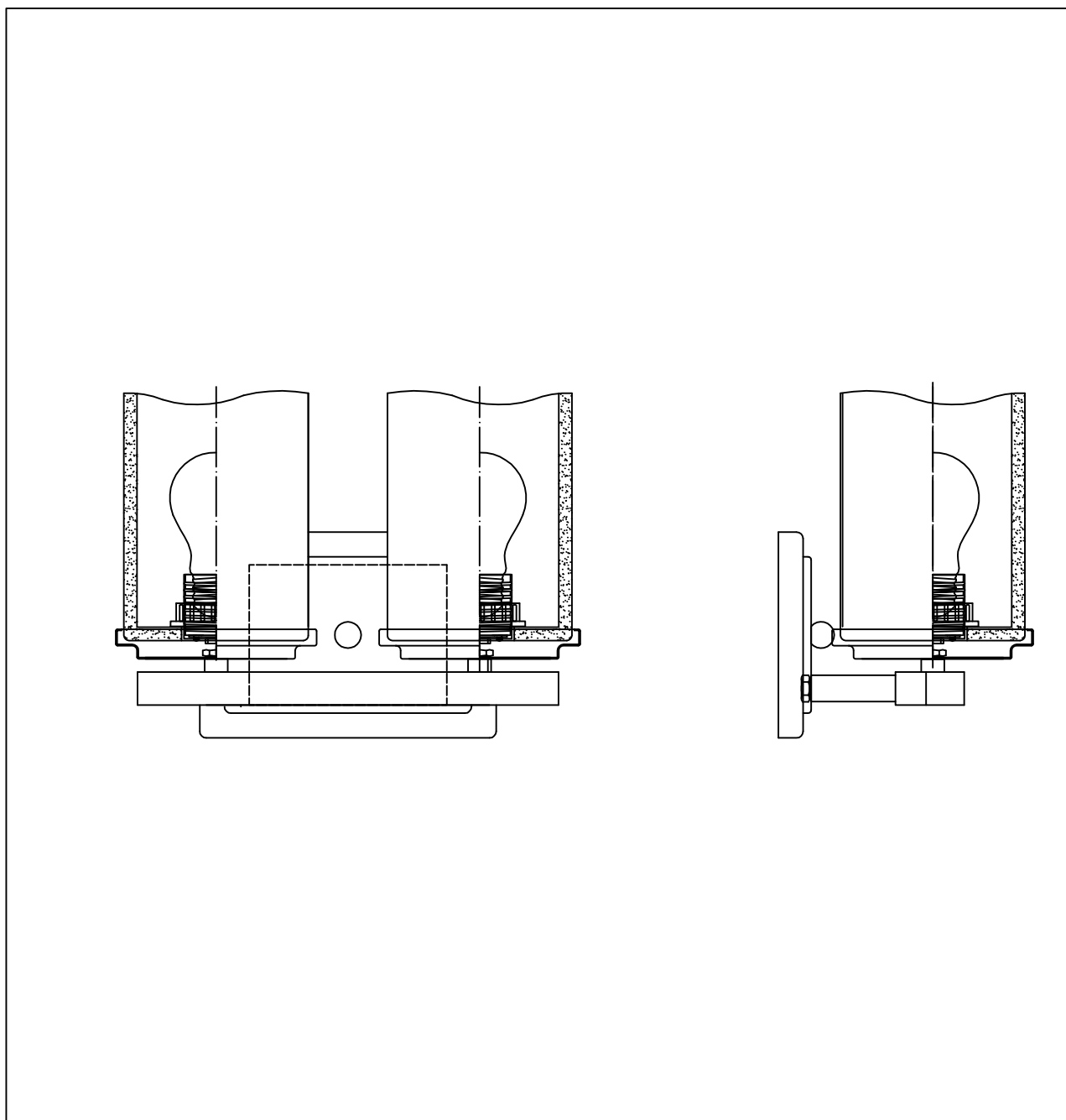

PRODUCT NAME: Luminous
ITEM NUMBER: 21142

Please consult your electrician for Hang fixture and wiring.



Bulb(not included) :2*MB 60W

**PRODUCTS ARE NOT INENDED
FOR COMMERCIAL USE.**

MADE IN CHINA
Page 1 of (3)

IMPORTANT: Turn off power at the main fuse or circuit breaker box before starting installation



(A) Bracket

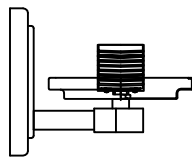

(B) Body



(C) Ball nut

Locate all hardware & components before discarding packaging

1.)

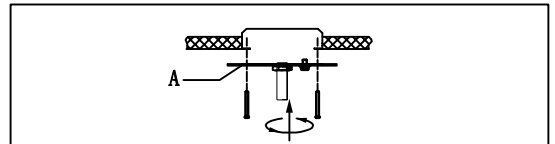

Step. 1: Remove mounting bracket(A) from fixture and install to electrical box.

2.)

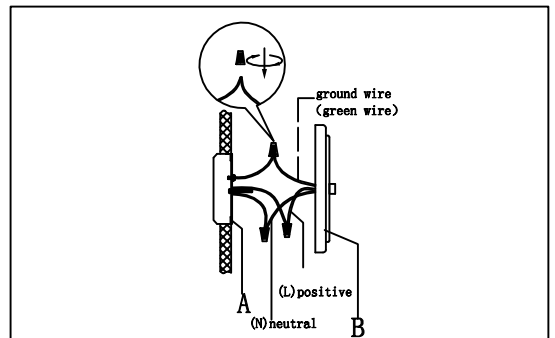

Step. 2: Wire fixture to wires in outlet box. Copper/Green wire is for Ground.

3.)

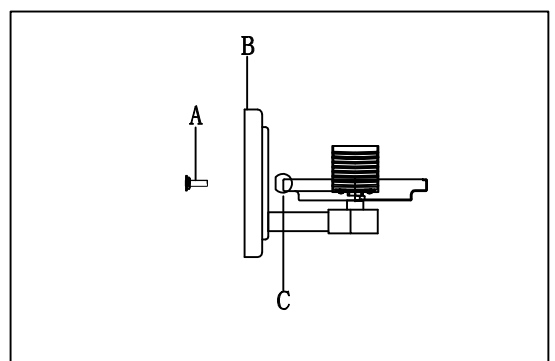

Step. 3: Install fixture to bracket(A) and tighten ball nuts (C) on the backplate to secure.

Cleaning & Care:

Clean with soft cloth and a mild detergent.
Do not use abrasive cleaner.

IMPORTANT: Turn off power at the main fuse or circuit breaker box before starting installation

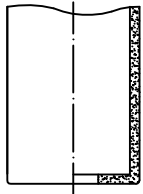

(D) Stone shade



(E) E27 Socket Ring



(F) Bulb

Locate all hardware & components before discarding packaging

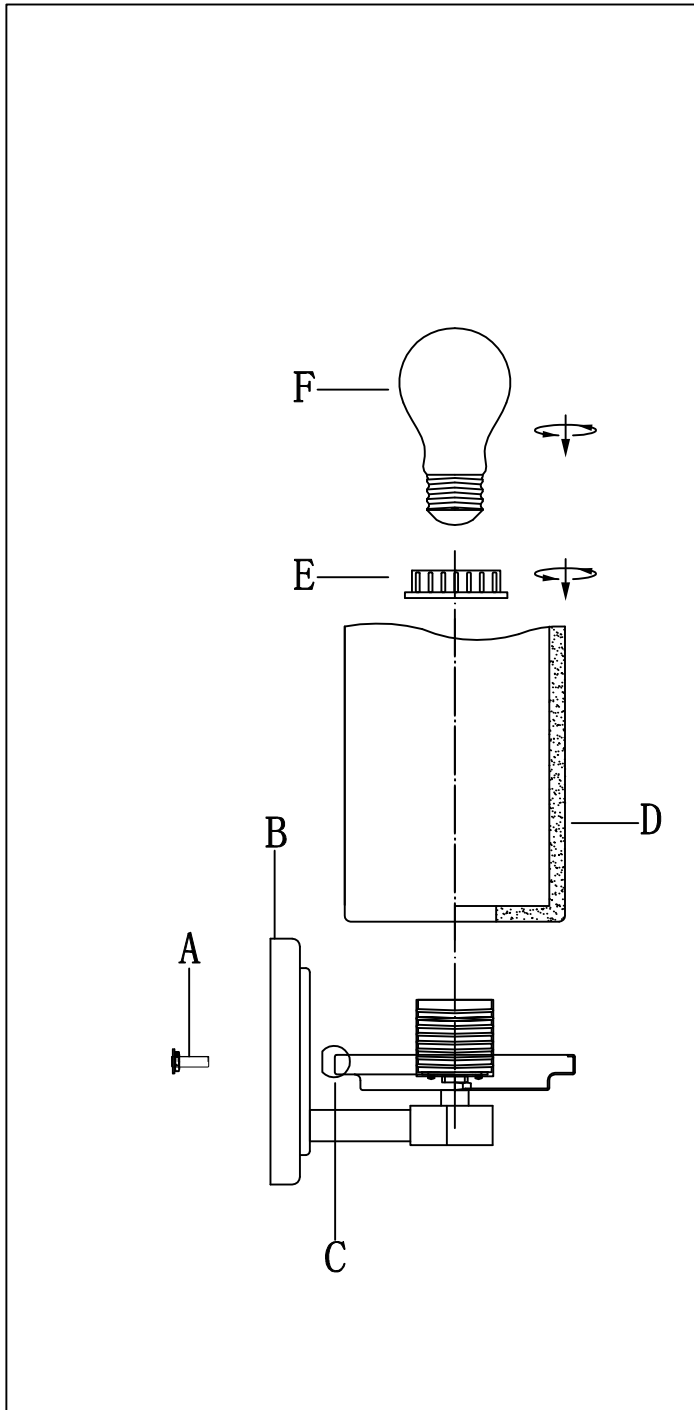

4.)

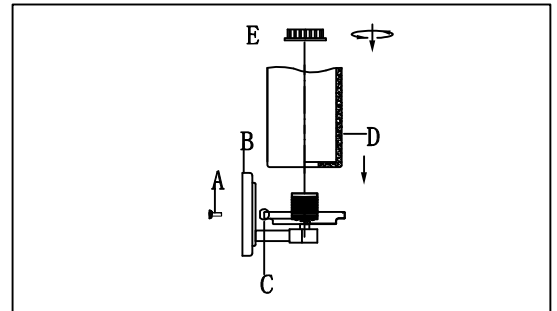

Step. 4: Place the Stone shade on the lamp body(C)

5.)

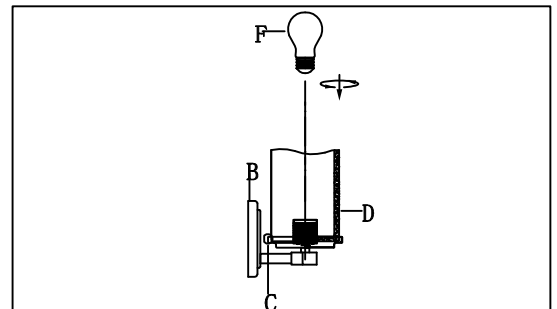

Step. 5: Install the bulb

Cleaning & Care:

Clean with soft cloth and a mild detergent.
Do not use abrasive cleaner.