

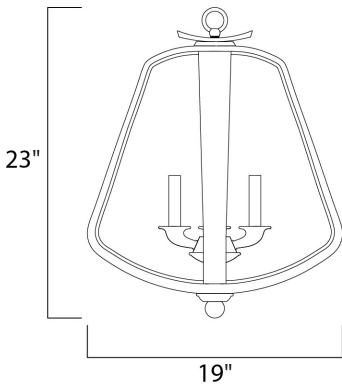

PRODUCT DESCRIPTION

Unique pendants formed of bent wood finished in Barnwood which is a weathered and distressed look. The internal clusters and details are constructed of cast iron in a hammered pattern and finished in a natural looking Iron Ore. A excellent blend of soft shape and rustic finish allows for this collection to fit into a number of interior designs.



MEASUREMENTS

DIMENSION : 19" L x 19" W x 23" H
 MAX OAH : 64.13" OAH
 CANOPY : 7.5" W x 1.38" H x 7.5" L
 HANGING WEIGHT : 10.45 lb

LAMPING

INPUT VOLTAGE : 120V
 LUMENS : 0 Rated
 BULB : 4 x 40W Incandescent E12 Candelabra , 160W Total
 BULB INCLUDED : (Not Included)
 DIMMABLE : Yes

FINISHES OPTION

 Barn Wood / Iron Ore

MATERIAL

Wood, Steel, Cast Aluminum

RATINGS

cETLus
 Dry Location



ADDITIONAL

OPERATING TEMPERATURE:
 -20°C (-4°F), 40°C (104°F)

Always consult a qualified electrician before installing any lighting product.