

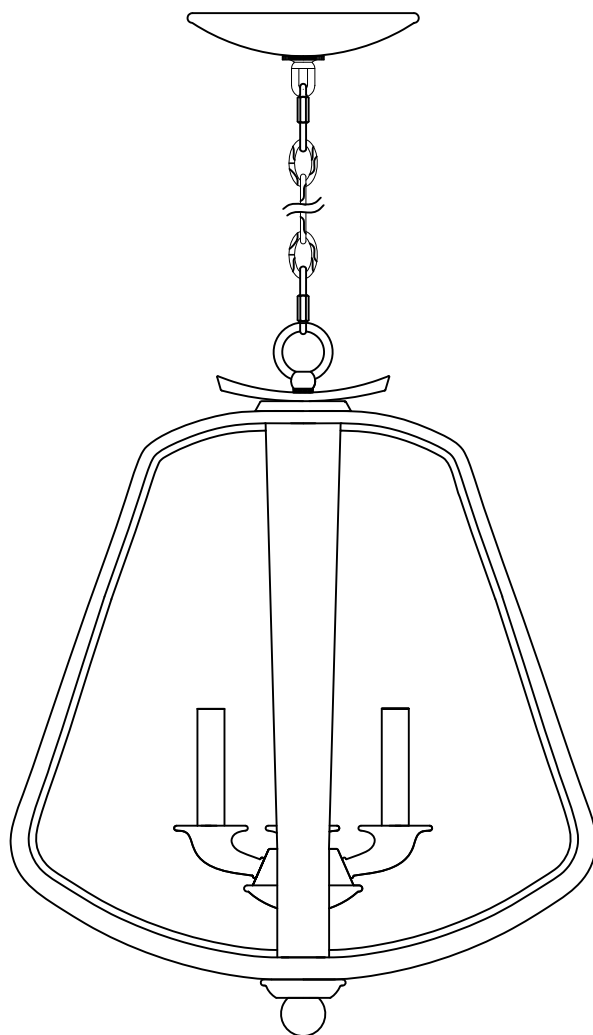

PRODUCT NAME: Road House 4 lt Chandelier
ITEM NUMBER: 20923BWIO

Please consult your electrician for hanging fixture and wiring.



Bulb(not included): 4-40 Watt Candelabra Base Bulbs

IMPORTANT: Turn off the power at the main fuse or circuit breaker box before starting installation

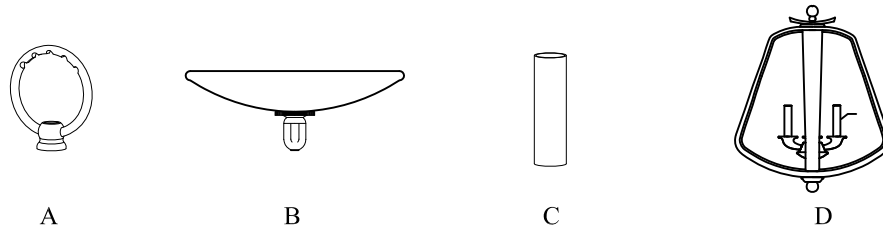

Locate all hardware & components before discarding packaging

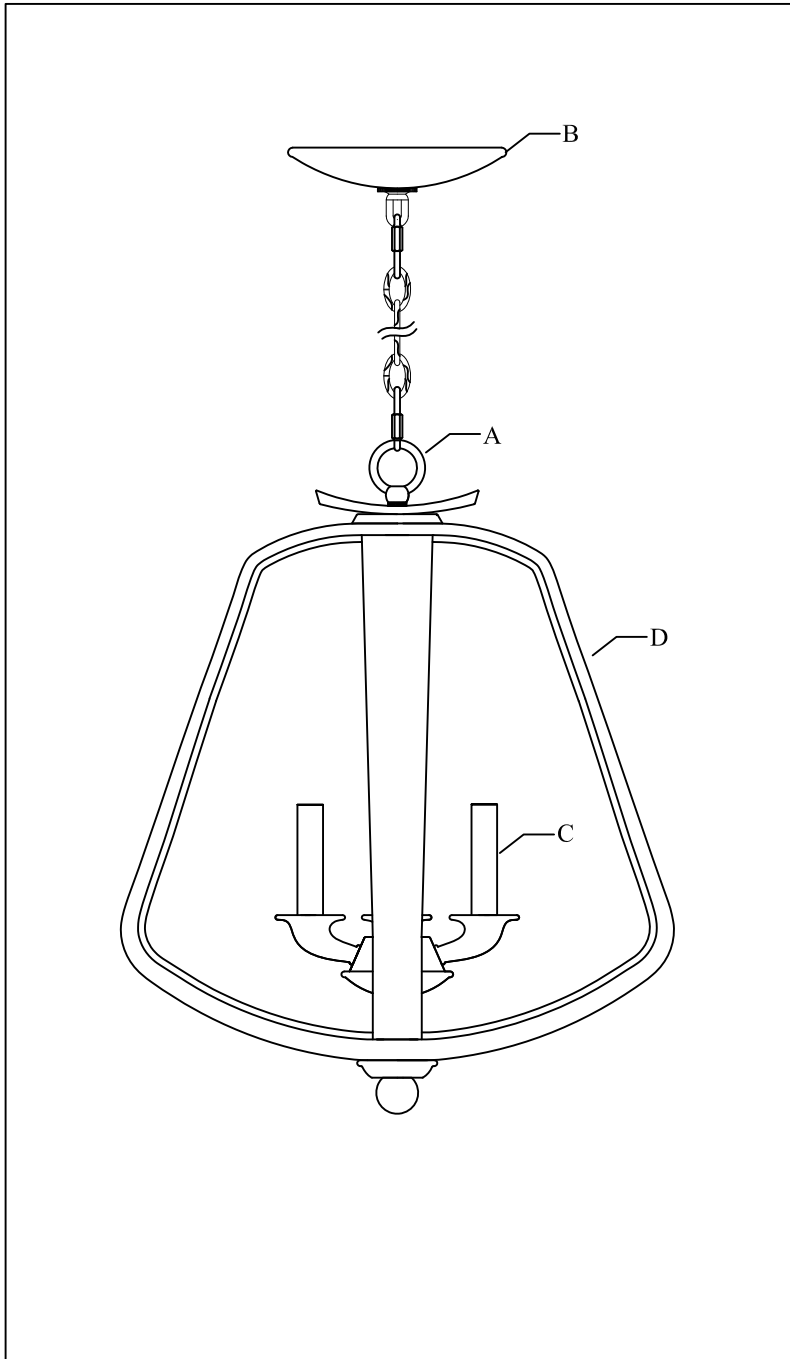

Cleaning & Care:
Clean with soft cloth and a mild detergent.
Do not use abrasive cleaner.

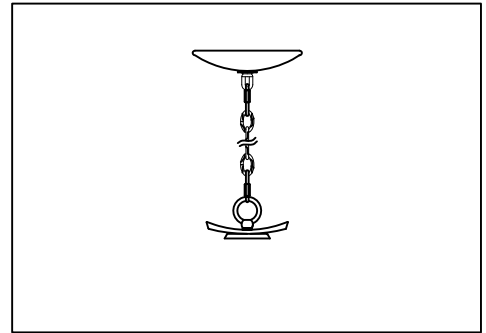

1.)

Step.1: Install top loop (A) and attach desired amount of chain to loop to achieve desired mounting height. Thread wire through every 3rd loop of chain. Place Candle Covers (C) over sockets.

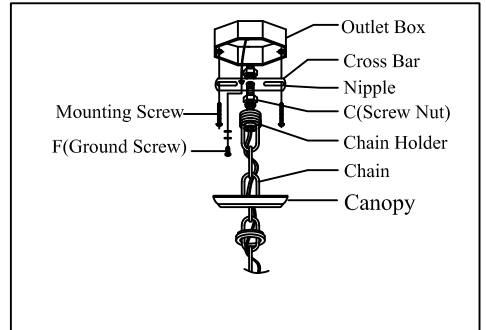

2.)

Step.2: Attach cross bar to outlet box. Remove ring from loop and slide down chain. Place canopy onto chain and let slide to top of fixture. Install nipple on cross bar above chain holder.

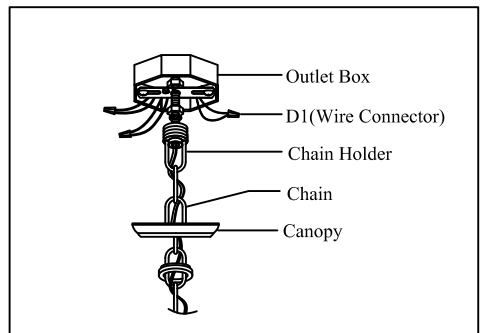

3.)

Step.3: Wire fixture to wires in outlet box. Copper wire is for Ground. Pull canopy through screw ring up chain to ceiling and tighten securely.