

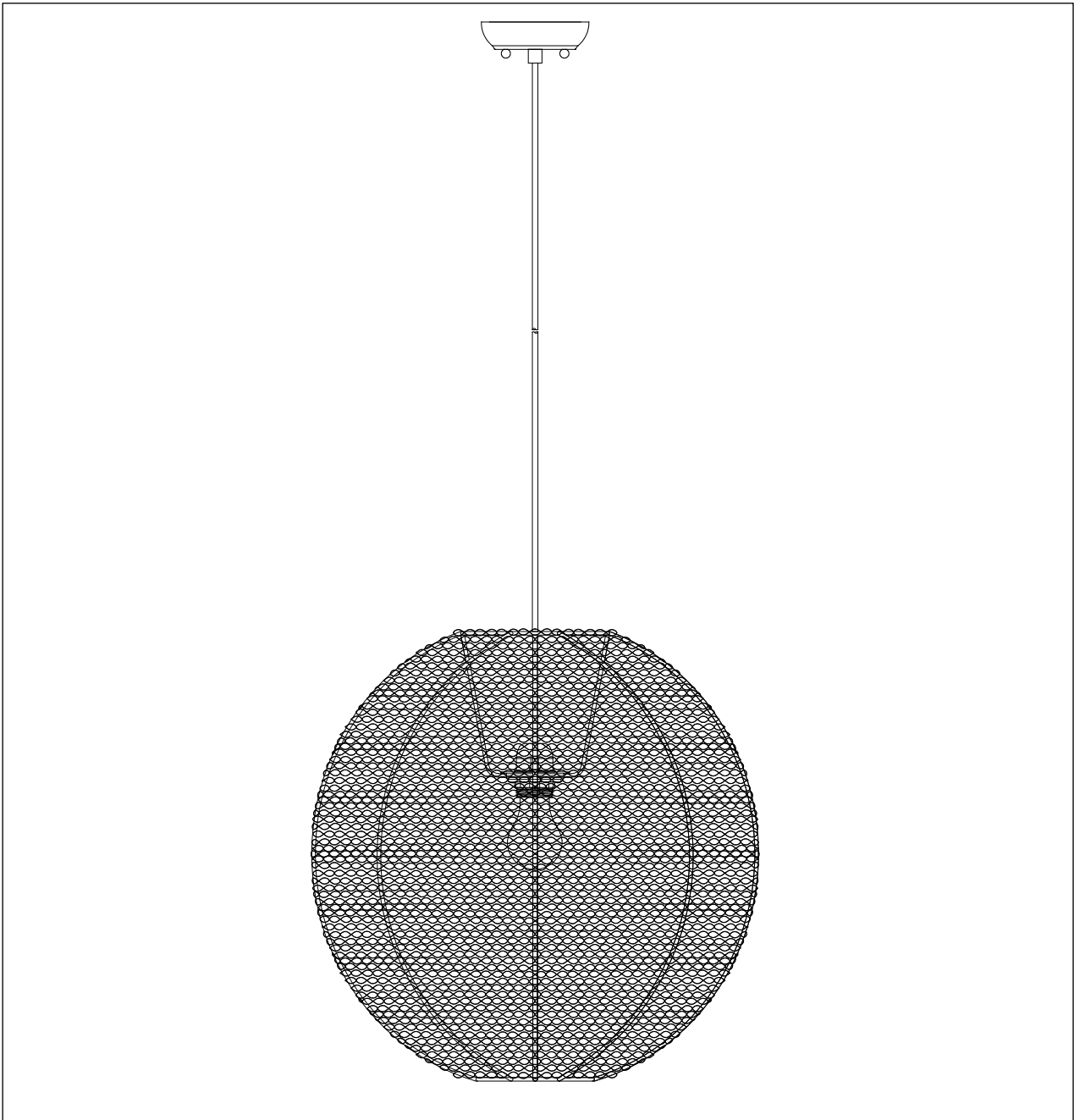

PRODUCT NAME:Twisp 1-Light Pendant
ITEM NUMBER:12195CP/PC

Please consult your electrician for hanging fixture and wiring.



Bulb(not included):40W E26

PRODUCTS ARE NOT INTENDED
FOR COMMERCIAL USE.

MADE IN CHINA
Page 1 of (3)

IMPORTANT: Turn off the power at the main fuse or circuit breaker box before starting installation

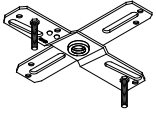

Bracket(A)

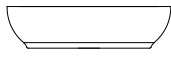

Canopy(B)



Finial(C)



Body(D)

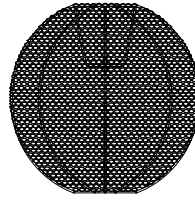

Shade(E)



Outer Ring(F)

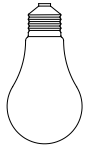

Bulb(G)

Locate all hardware & components before discarding packaging

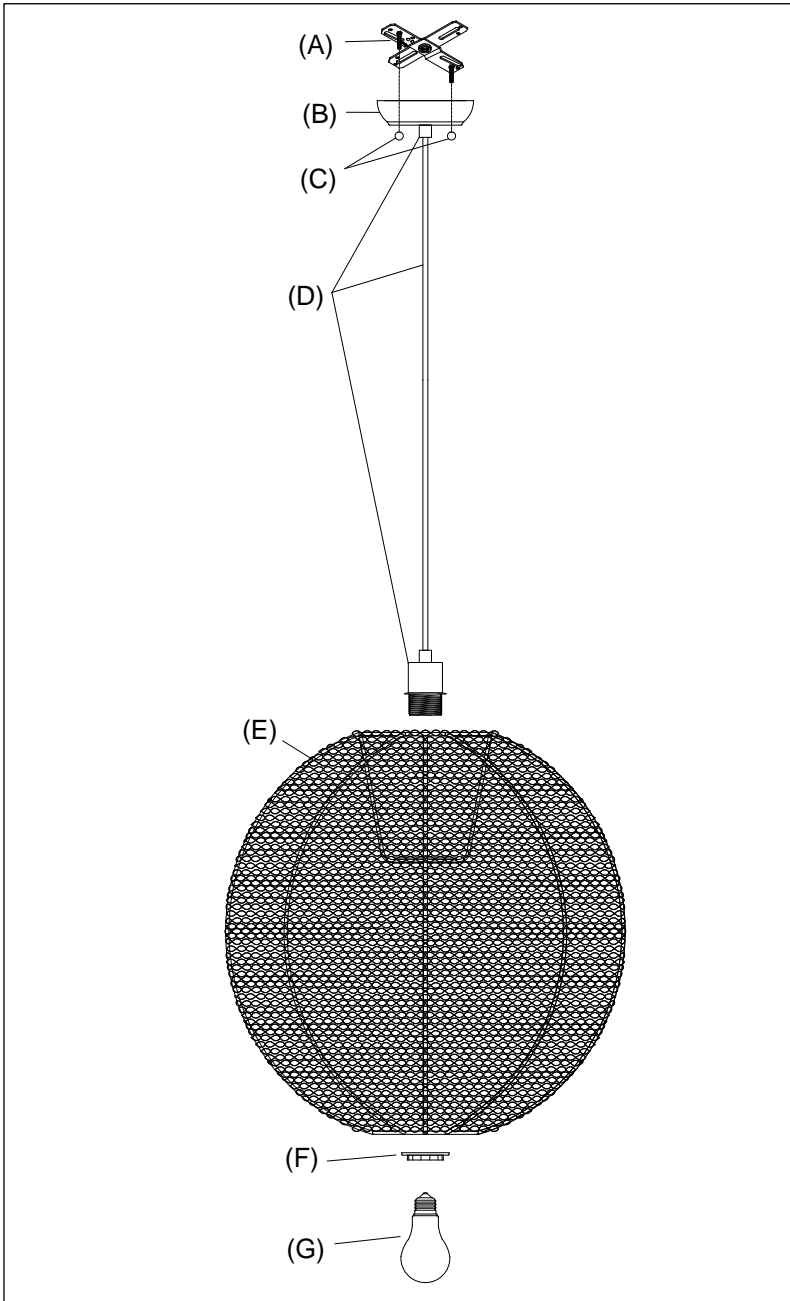

1.)

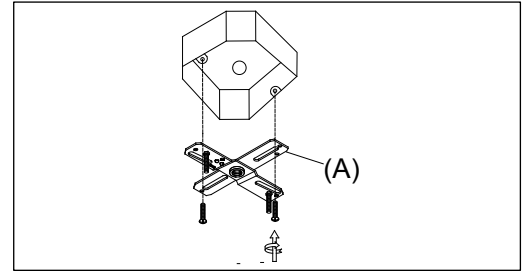

Step.1: Remove mounting bracket(A) from fixture and install to electrical box.

2.)

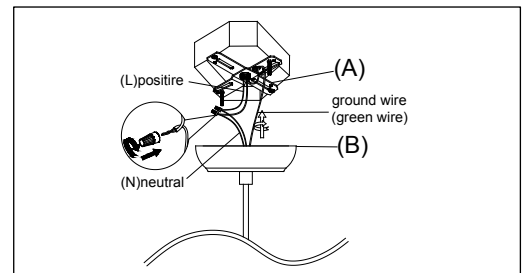

Step.2: Wire fixture to wires in outlet box. Green wire is for Ground.

3.)

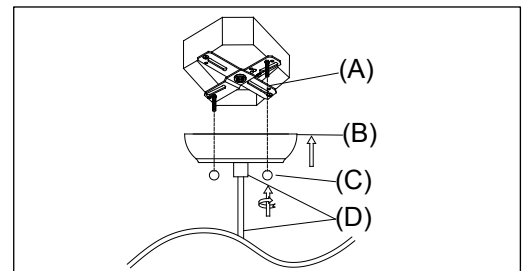

Step.3: Adjust wire length to desired mounting height, and tighten strain relief screws to secure. Install body(D) to bracket(A) and tighten finials (C) on the canopy (B) to secure.

Cleaning & Care:

Clean with soft cloth and a mild detergent.

Do not use abrasive cleaner.

IMPORTANT: Turn off the power at the main fuse or circuit breaker box before starting installation

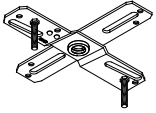

Bracket(A)

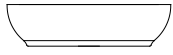

Canopy(B)



Finial(C)



Body(D)

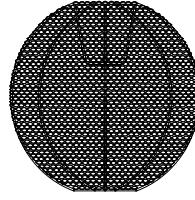

Shade(E)



Outer Ring(F)

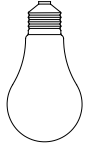

Bulb(G)

Locate all hardware & components before discarding packaging

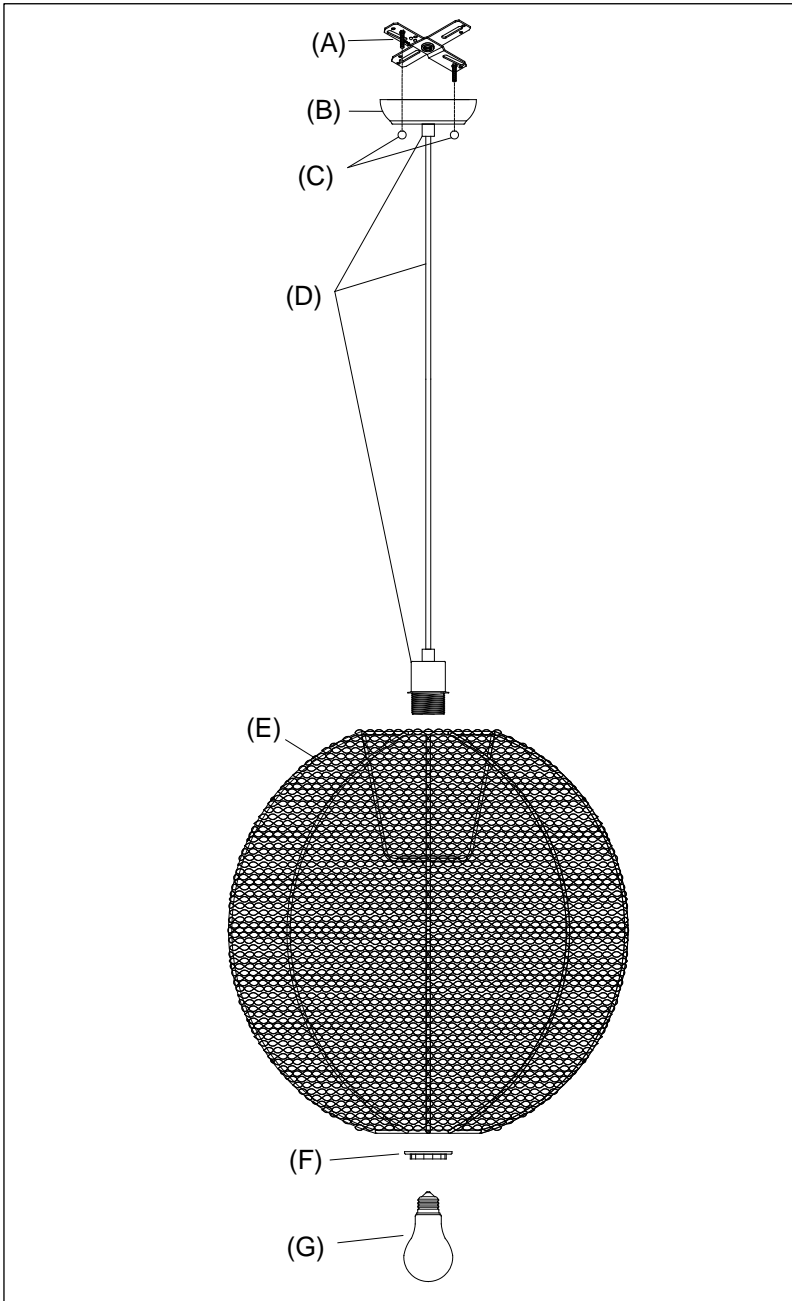

4.)

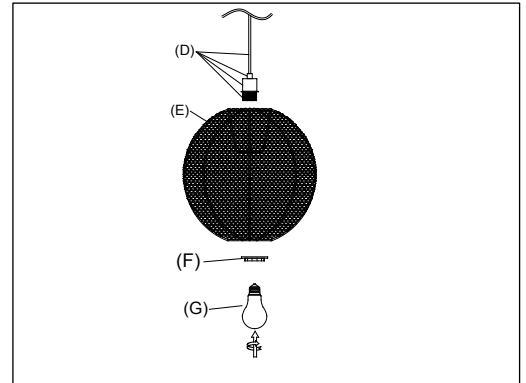

Step.4: Run socket (D) through shade (E) and secure using screw outer ring (F) on socket. Screw in incandescent bulb (G).

Cleaning & Care:

Clean with soft cloth and a mild detergent.

Do not use abrasive cleaner.