



Lighting Your Life Since 1970

Product Specifications - 1051BK

Job Name:	Job Type:
Quantity:	Comments:



**1051BK**  
North Church 1-Light Outdoor Wall Lantern

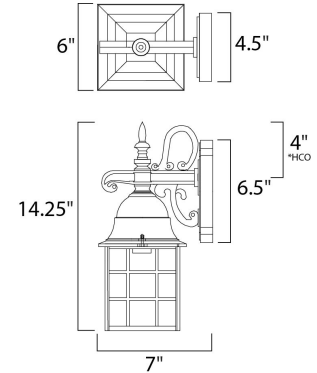

\*height from center of outlet to the top of the fixture

**Finish**  
Black

**Glass/Shade**  
Clear

**Product Category**  
Outdoor Wall Mount

**Lamping**

Number of Bulbs	1
Light Type	Incandescent
Bulb Type	MB
Max Bulb Wattage	100
Max Fixture Wattage	100
Rated Life	±2,500 Hours
Rated Lumens	±1,150
Color Temp	±2,700 K
Bulb(s)	Not Included
Light Up/Down	N/A
Beam Spread	N/A
CRI	N/A
Photo Cell Included	N/A
Ballast/Driver/Transformer	No
Dimmable	Standard

**Measurements**

Width	6.00"
Height	14.25"
Length	N/A
Extension	7"
Back Plate Width	4.50"
Back Plate Height	6.50"
HCO	4.00"
Min Overall Height	0.00"
Max Overall Height	N/A
Hanging Weight	2.68 lbs
Height Adjustable	N/A
Slope	N/A
Chain Length	N/A
Wire Length	N/A
Canopy Width	N/A
Canopy Height	N/A
Canopy Length	N/A

**Shipping**

Carton Weight	3.48 lbs
Carton Width	7"
Carton Height	15"
Carton Length	9"
Carton Cubic Feet	0.52
Master Pack	6
Master Pack Weight	23.07 lbs
Master Pack Width	18.11"
Master Pack Height	15.35"
Master Pack Length	22.24"
Master Cubic Feet	3.58
UPS Shippable	Yes

**Certification**

Safety Rating	Wet
Energy Star	No
CA Title 24	No
CA Title 20	No
ADA	No
Dark Sky	N/A

**Other**

UPC Code	783209105102
Shades Included	N/A
Crystals Included	N/A
Diffuser Included	N/A
Conversion Kit	N/A
Material	Die Cast Aluminum

**Equivalents**

Incandescent Watts	N/A
Fluorescent Watts	N/A

Maxim Lighting International and all designs, logos and images © 2015 Maxim Lighting International. All Rights Reserved. Maxim Lighting International reserves the right, at any time, to make changes in the design and/or construction of the product including the discontinuation of product without prior notice. Color may vary from what is pictured above due to limitations inherent to photographic processes.

Always consult a qualified, licensed electrician before installation of any product weighing 35 pounds or more. We recommend that a qualified, licensed electrician do the installation. Always install to a mechanically sound structure.