



Lighting Your Life Since 1970

Product Specifications - 1025WT

Job Name:	Job Type:
Quantity:	Comments:



1025WT
Builder Cast 1-Light Outdoor Wall
Lantern

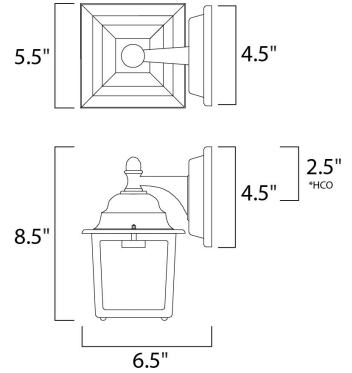

*height from center of outlet to the top of the fixture

Finish
 White

Glass/Shade
 Clear

Product Category
 Outdoor Wall Mount

Lamping

Number of Bulbs	1
Light Type	Incandescent
Bulb Type	MB
Max Bulb Wattage	60
Max Fixture Wattage	60
Rated Life	±2,500 Hours
Rated Lumens	±672
Color Temp	±2,700 K
Bulb(s)	Not Included
Light Up/Down	N/A
Beam Spread	N/A
CRI	N/A
Photo Cell Included	N/A
Ballast/Driver/Transformer	No
Dimmable	Standard

Measurements

Width	5.50"
Height	8.50"
Length	N/A
Extension	7"
Back Plate Width	4.50"
Back Plate Height	4.50"
HCO	2.50"
Min Overall Height	0.00"
Max Overall Height	8.50"
Hanging Weight	1.58 lbs
Height Adjustable	N/A
Slope	N/A
Chain Length	N/A
Wire Length	N/A
Canopy Width	N/A
Canopy Height	N/A
Canopy Length	N/A

Shipping

Carton Weight	2.18 lbs
Carton Width	6"
Carton Height	10"
Carton Length	8"
Carton Cubic Feet	0.28
Master Pack	6
Master Pack Weight	9.50 lbs
Master Pack Width	16.50"
Master Pack Height	11.02"
Master Pack Length	19.30"
Master Cubic Feet	2.03
UPS Shippable	Yes

Certification

Safety Rating	Wet
Energy Star	No
CA Title 24	No
CA Title 20	No
ADA	No
Dark Sky	N/A

Other

UPC Code	783209102569
Shades Included	N/A
Crystals Included	N/A
Diffuser Included	N/A
Conversion Kit	N/A
Material	Die Cast Aluminum

Equivalents

Incandescent Watts	N/A
Fluorescent Watts	N/A

Maxim Lighting International and all designs, logos and images © 2015 Maxim Lighting International. All Rights Reserved. Maxim Lighting International reserves the right, at any time, to make changes in the design and/or construction of the product including the discontinuation of product without prior notice. Color may vary from what is pictured above due to limitations inherent to photographic processes.

Always consult a qualified, licensed electrician before installation of any product weighing 35 pounds or more. We recommend that a qualified, licensed electrician do the installation. Always install to a mechanically sound structure.