

Contemporary Lighting

PRODUCT NAME: Alumilux
ITEM NUMBER: E41490

Please consult your electrician for hanging fixture and wiring.

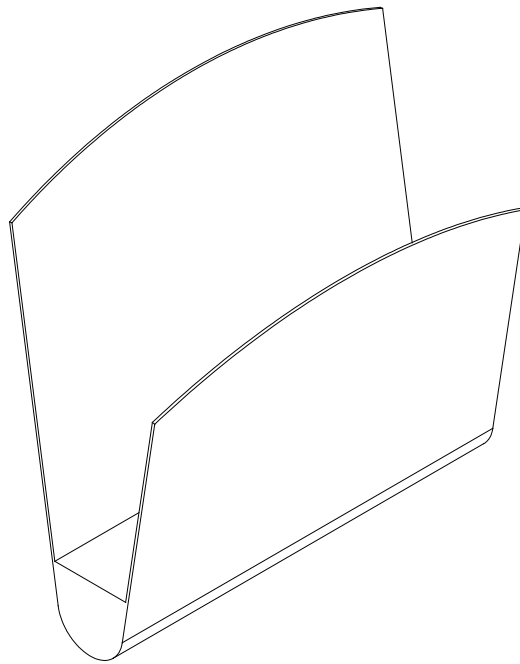

To prevent water intrusion, caulk around back-plate where fixture meets the wall using outdoor silicone sealant. Leave a small gap at the bottom to allow moisture to exit.

WARNING: Wires need to be connected to driver found in canopy and should not be connected directly to power source or a short may occur.

The fixture is designed to dim with a standard Triac forward phase dimmer. Dimming levels will vary by dimmer.

Below is a list of recommended dimmers:

- Lutron MACL-153M
- Lutron DVL-153P
- Lutron SCL-153P
- Leviton IPL06-10Z
- Leviton 6674-POW

Due to inrush current wattage should not exceed 150 watts of product for a 600 watt dimmer.

WARNING: Wires need to be connected to driver found in canopy and should not be connected directly to power source or a short may occur.

LED 18W

IMPORTANT: Turn off the power at the main fuse or circuit breaker box before starting installation

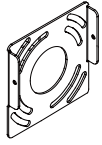

(A)

Mounting bracket



(B)

Wire Nuts (x3)



(C)

Mounting screws (x4)

Locate all hardware & components before discarding packaging

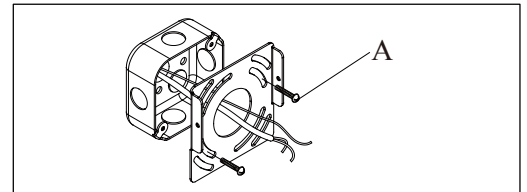
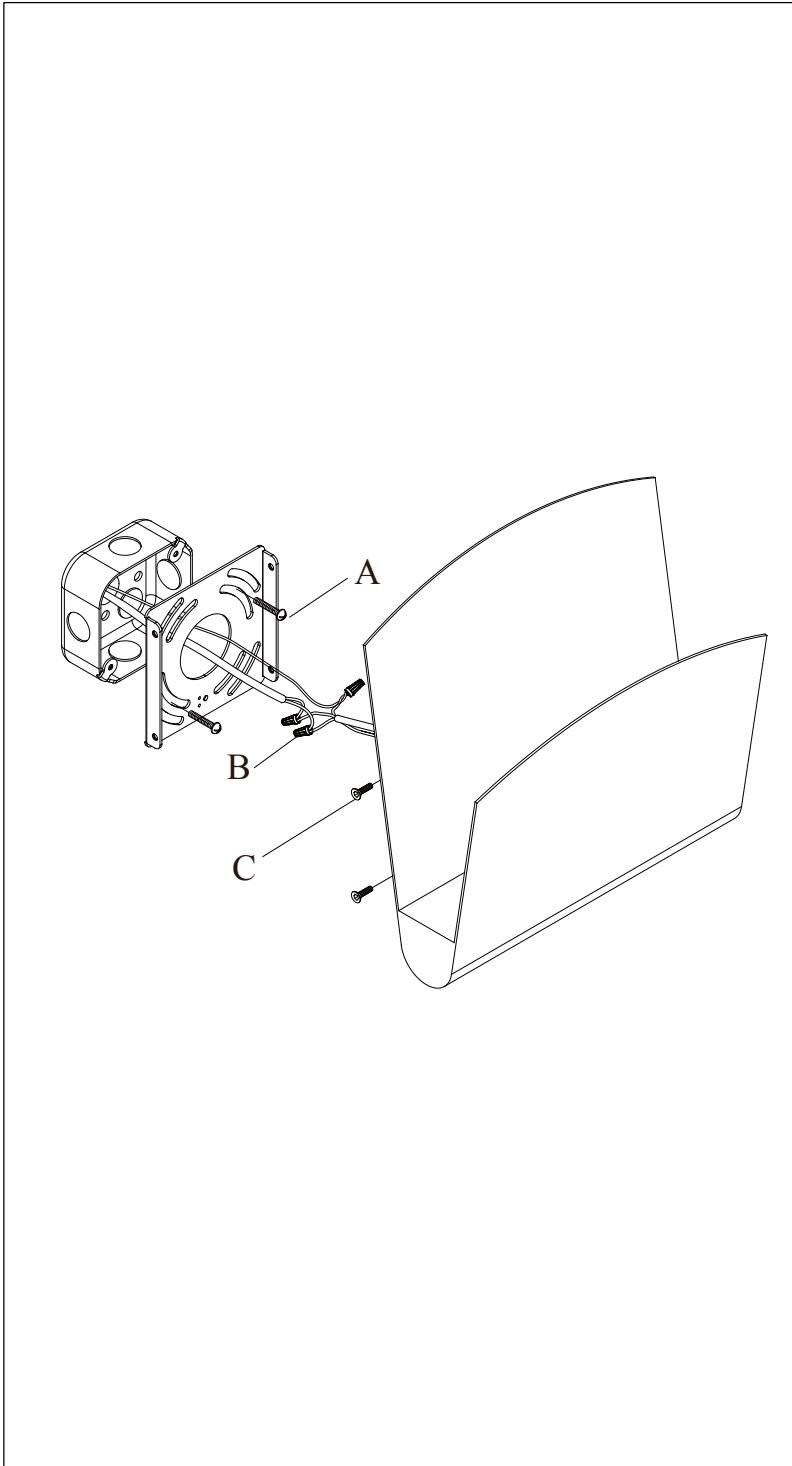

1.)

Step.1: Install Mounting bracket(A) to outlet box.

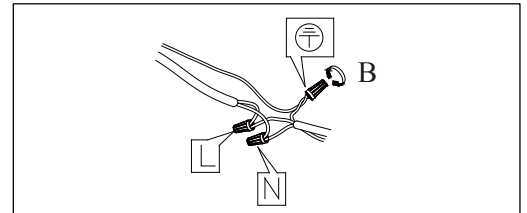

2.)

Step.2: Wire fixture to wires in outlet box.
Green/Copper wire is for Ground.

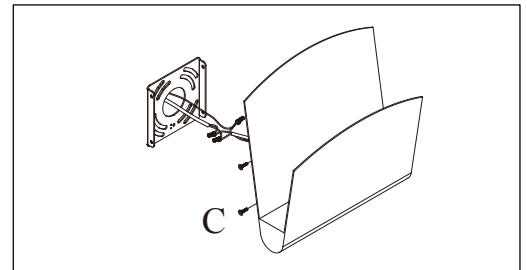

3.)

Step.3: Caulk around fixture with outdoor silicone sealant to prevent water intrusion. Leave a small gap at the bottom to allow moisture to escape. Install fixture to mounting bracket(A) and tighten mounting screws (C) to secure.

Cleaning & Care:

Clean with soft cloth and a mild detergent.
Do not use abrasive cleaner.