

PRODUCT NAME: Flute LED 23-Light Pendant
ITEM NUMBER: E10020

Please consult your electrician for hanging fixture and wiring.

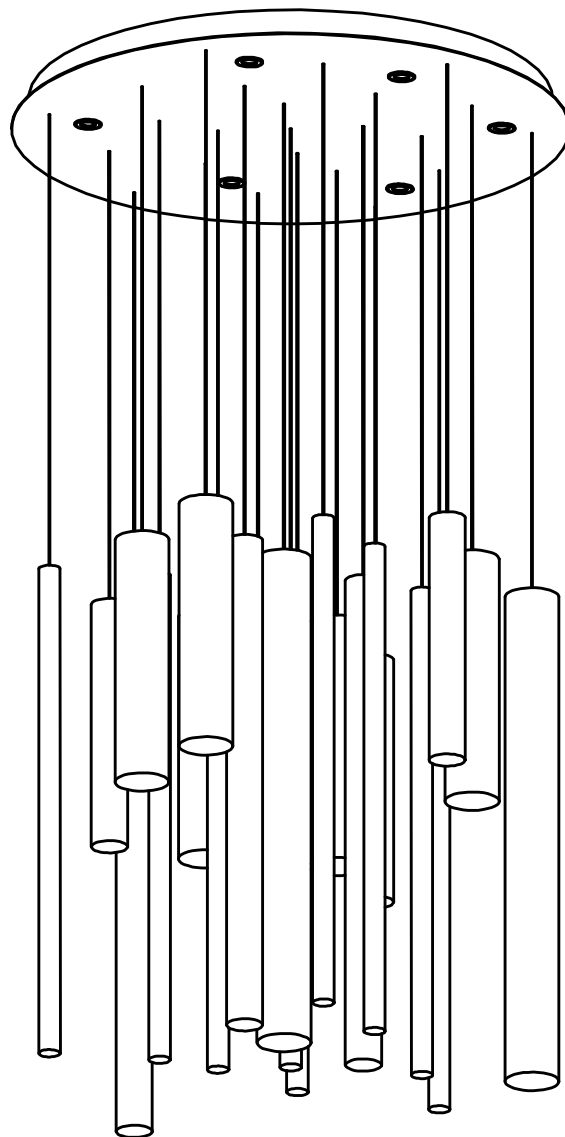

WARNING: Wires need to be connected to driver found in canopy and should not be connected directly to power source or a short may occur.

The fixture is designed to dim with a standard Triac forward phase dimmer.

Dimming levels will vary by dimmer.

Below is a list of recommended dimmers:

Lutron MACL-153M

Lutron DVL-153P

Lutron SCL-153P

Leviton IPL06-10Z

Leviton 6674-POW

Due to inrush current wattage should not exceed 150 watts of product for a 600 watt dimmer.

Bulbs (integrated): LED 92W

IMPORTANT: Turn off the power at the main fuse or circuit breaker box before starting installation

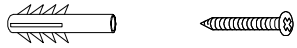

Screws*4PCS

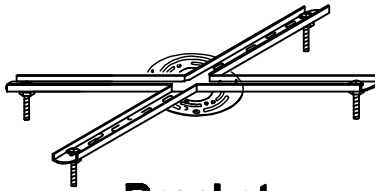

Bracket



Mounting Screws*4PCS

Locate all hardware & components before discarding packaging

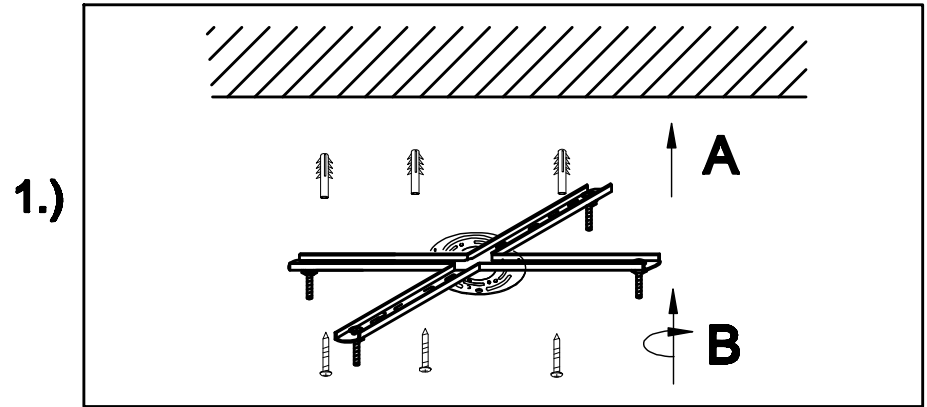
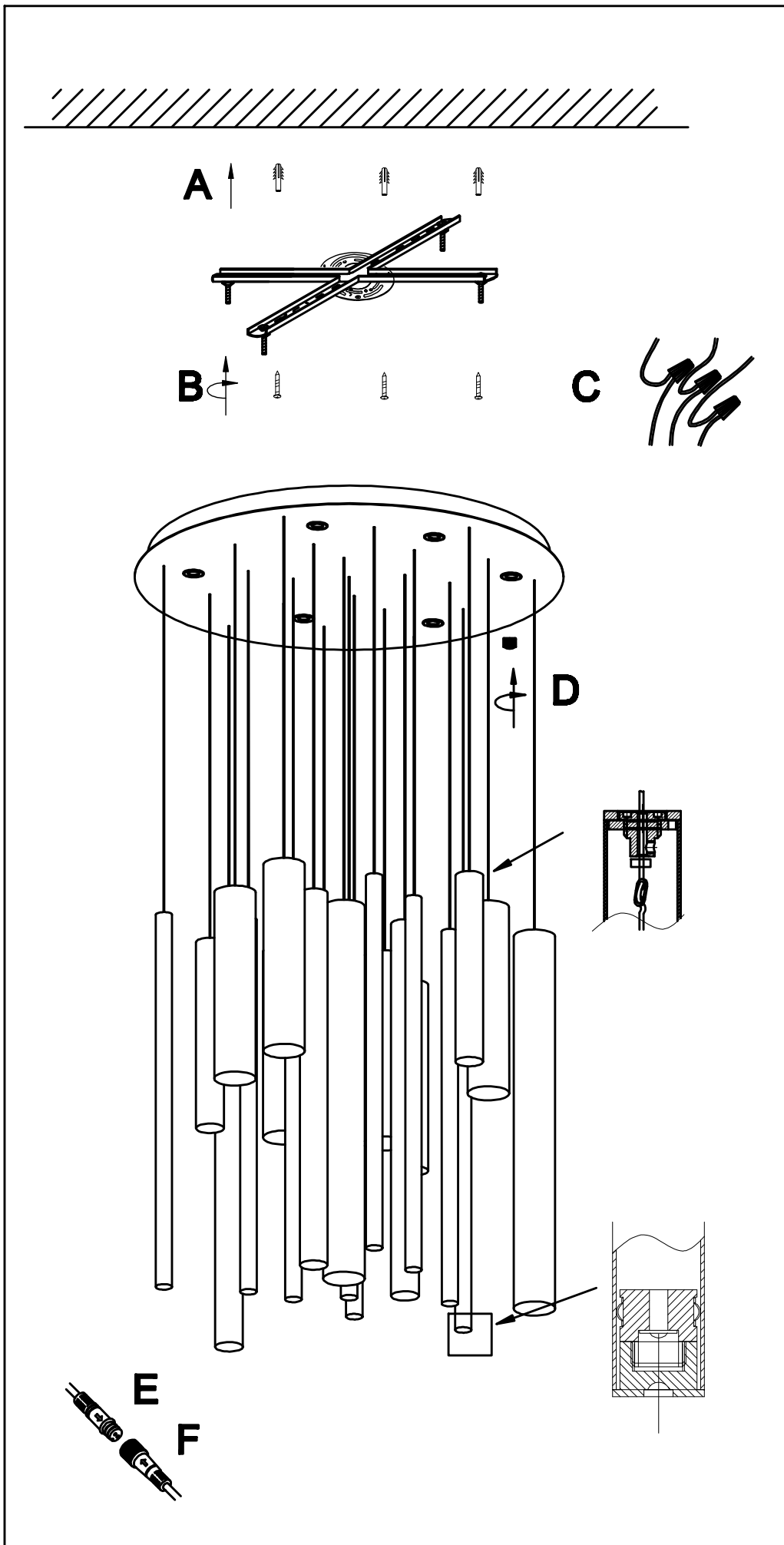

Step 1: Remove mounting bracket from fixture and install to electrical box.

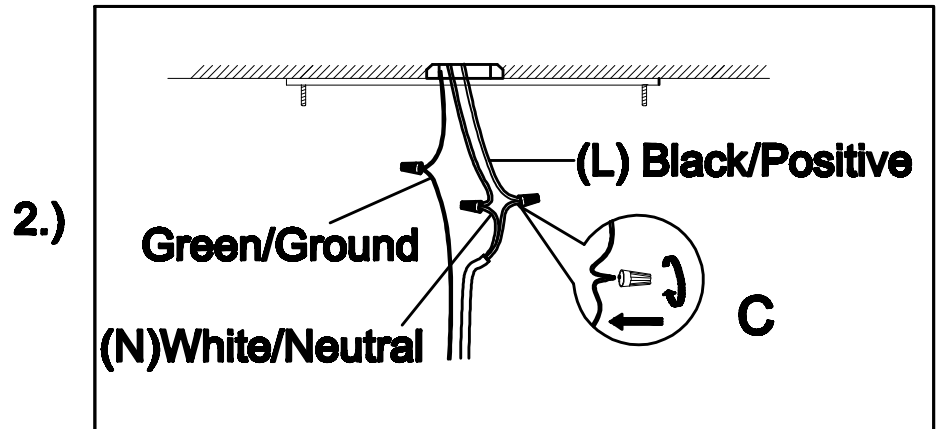

Step 2: Adjust wires to desired mounting height. Wire fixtures to wire in outlet box. Refer to dual plastic wire instructions to connect low voltage wire to driver.

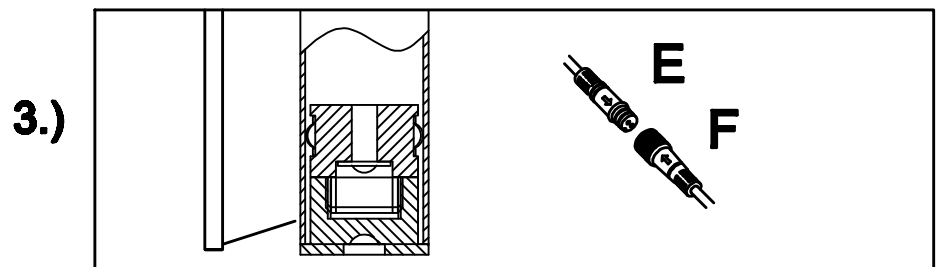

Run the wire through the tube and plug in (E) and (F) following the direction of written on the plug.

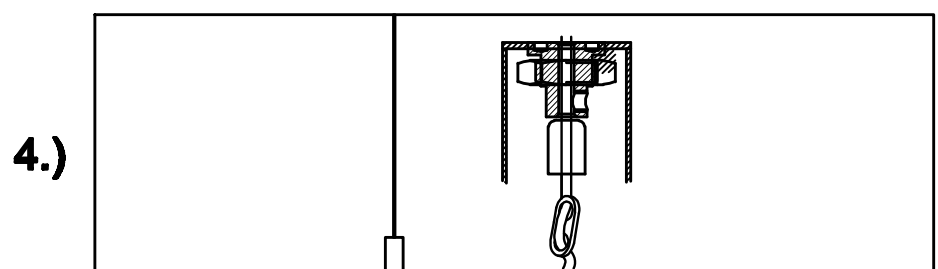

Tighten the top lid on the tube using the fork tool provided until flush.

Cleaning & Care:
You may use talcum powder and a soft cloth for cleaning. Do not use abrasive cleaner.

Please follow tube position
as drawing arrangement

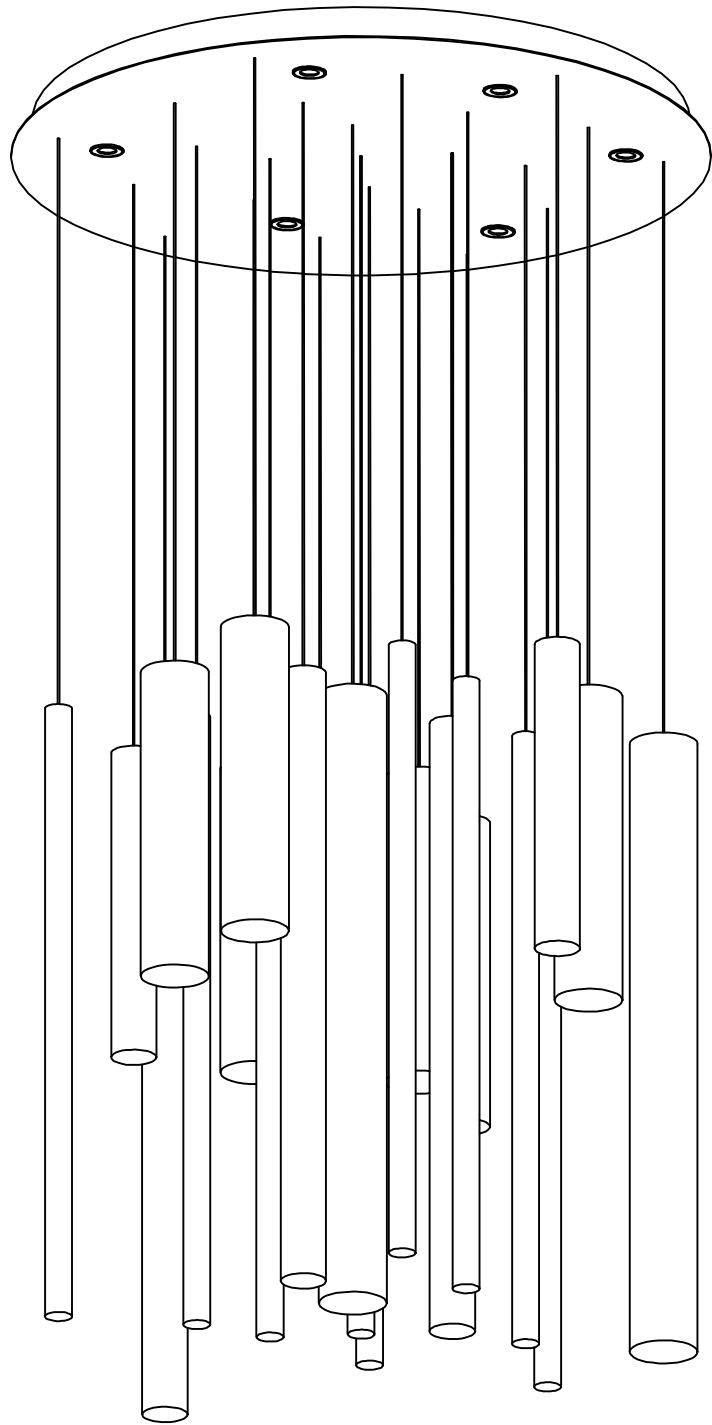

GO-Golden
PC-Chrome
RG-Rose golden
BK-Black

Upward View

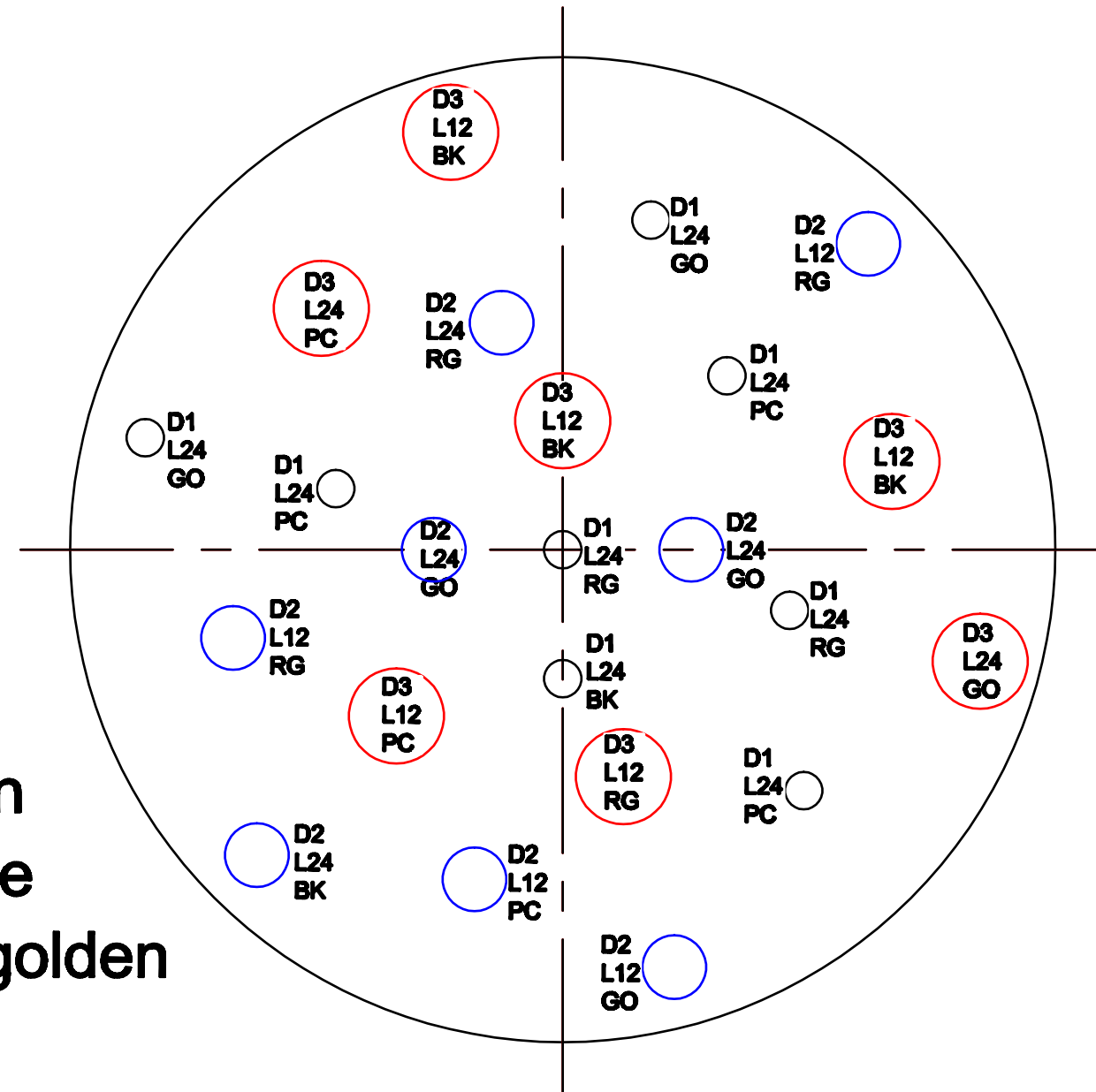

Please check the number wire and tube
to find correct pipe for install

D1=Thin= \varnothing 1"=1W

D2=Medium= \varnothing 1.75"=4W

D3=Wide= \varnothing 2.5"=7W

L12=L12"

L24=L24"

Pendant Wires

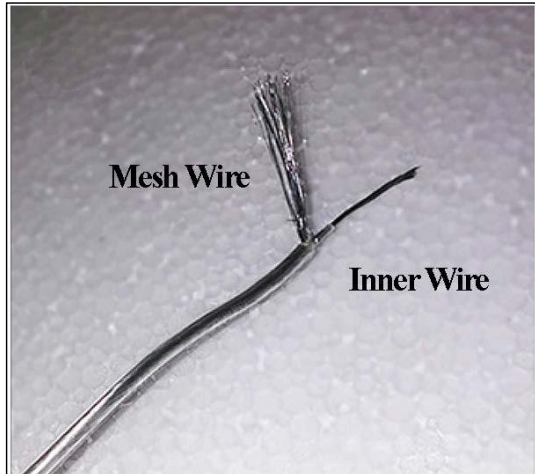

Driver Wires

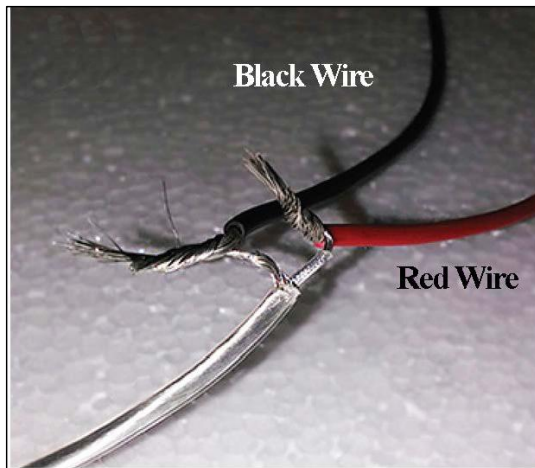

Pendant	Driver
InnerWire (+)	DriverRed (+)
Outer Mesh (-)	DriverBlack (-)

If wires are cut in the process of adjusting the height, please note the pendants consist of an outer mesh wire(ground) and inner(live) wire that must be separated before re-joining with the driver output wires. Pendant are wired in series to the drivers, as shown below

LED-D50V-350 LED-D40V-350 LED-D40V-350 LED-D40V-700 LED-D40V-700

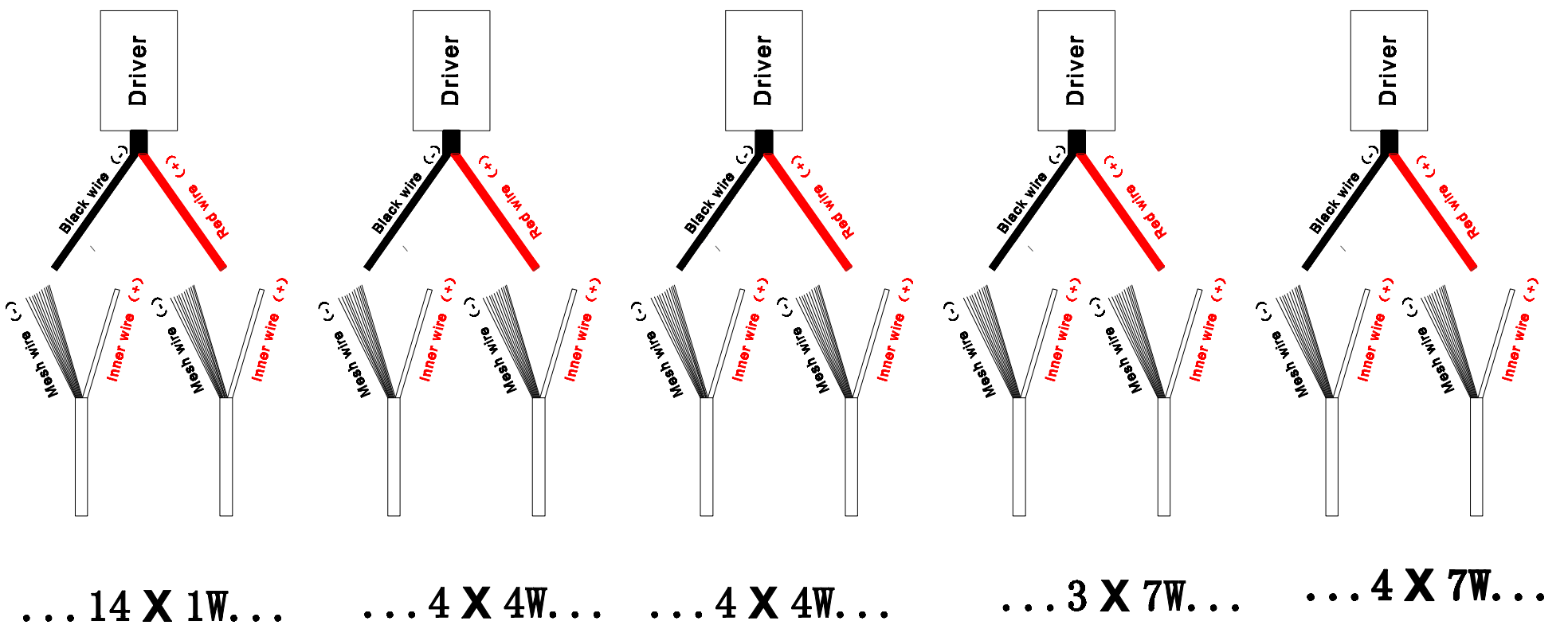

Dual Plastic Wiring Instructions

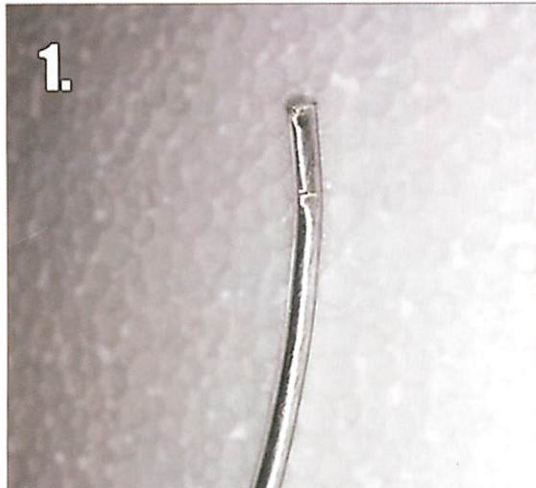

Strip the clear plastic off the pendant electrical wire.



Exposed is the mesh wire and the inner wire.

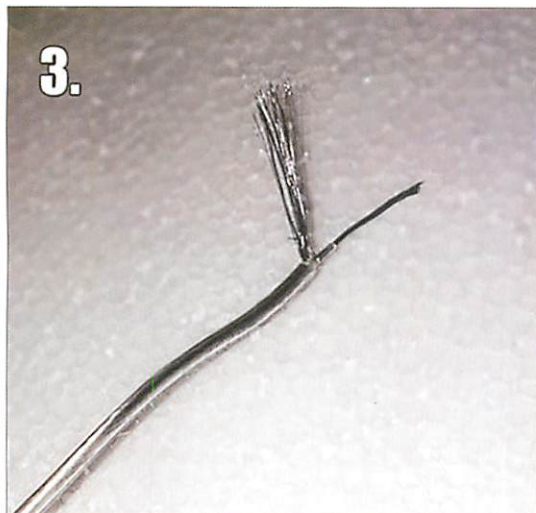

Pull the mesh wire away to isolate the inner wire. The inner wire will also have a plastic coat that needs to be stripped.

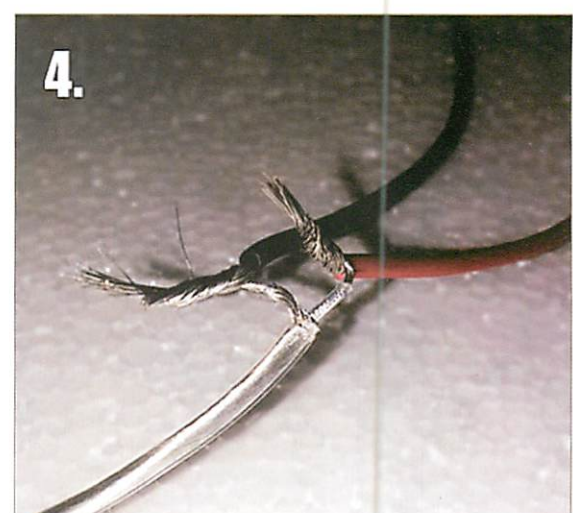

Once the two wires are formed, connect the mesh wire (ground) to the black wire and the inner wire to the red wire (live).